



IEC FUSES & FUSEGEAR

BS88 LV
FUSE LINKS
& FUSE HOLDERS
#3



MERSEN PROTECTION IN INDUSTRIAL APPLICATIONS

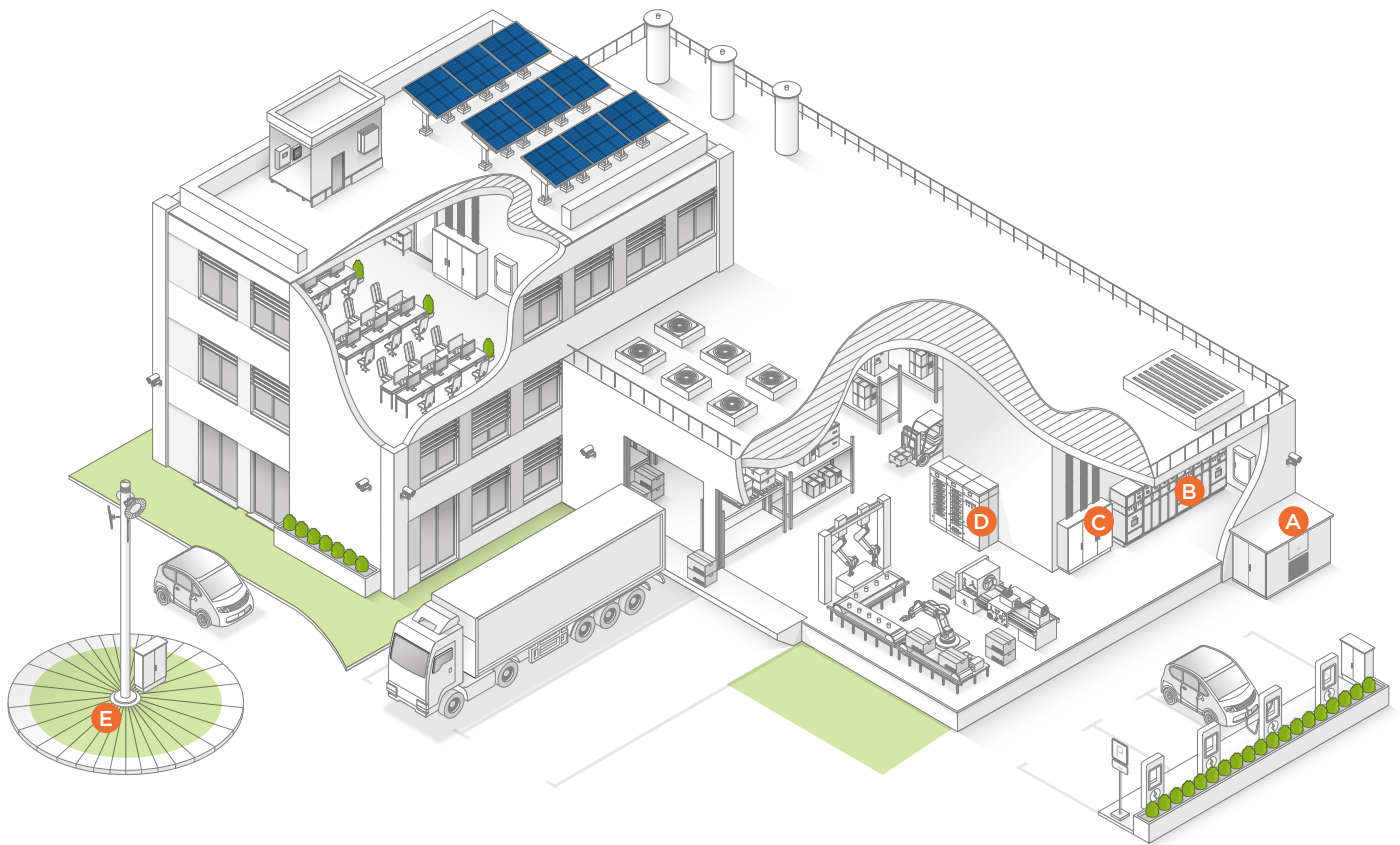

A

B

C

D

E



Main Incomer
BTLM 750



**Main Fuse
Combination Switch**
BTKF 315



**Distribution
Fuse Board**
BTC 100

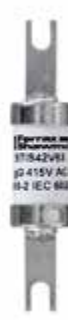

Switch Fuse
BTIS 63



Street Lighting
BLST 32

MERSEN PROTECTION IN RESIDENTIAL APPLICATIONS

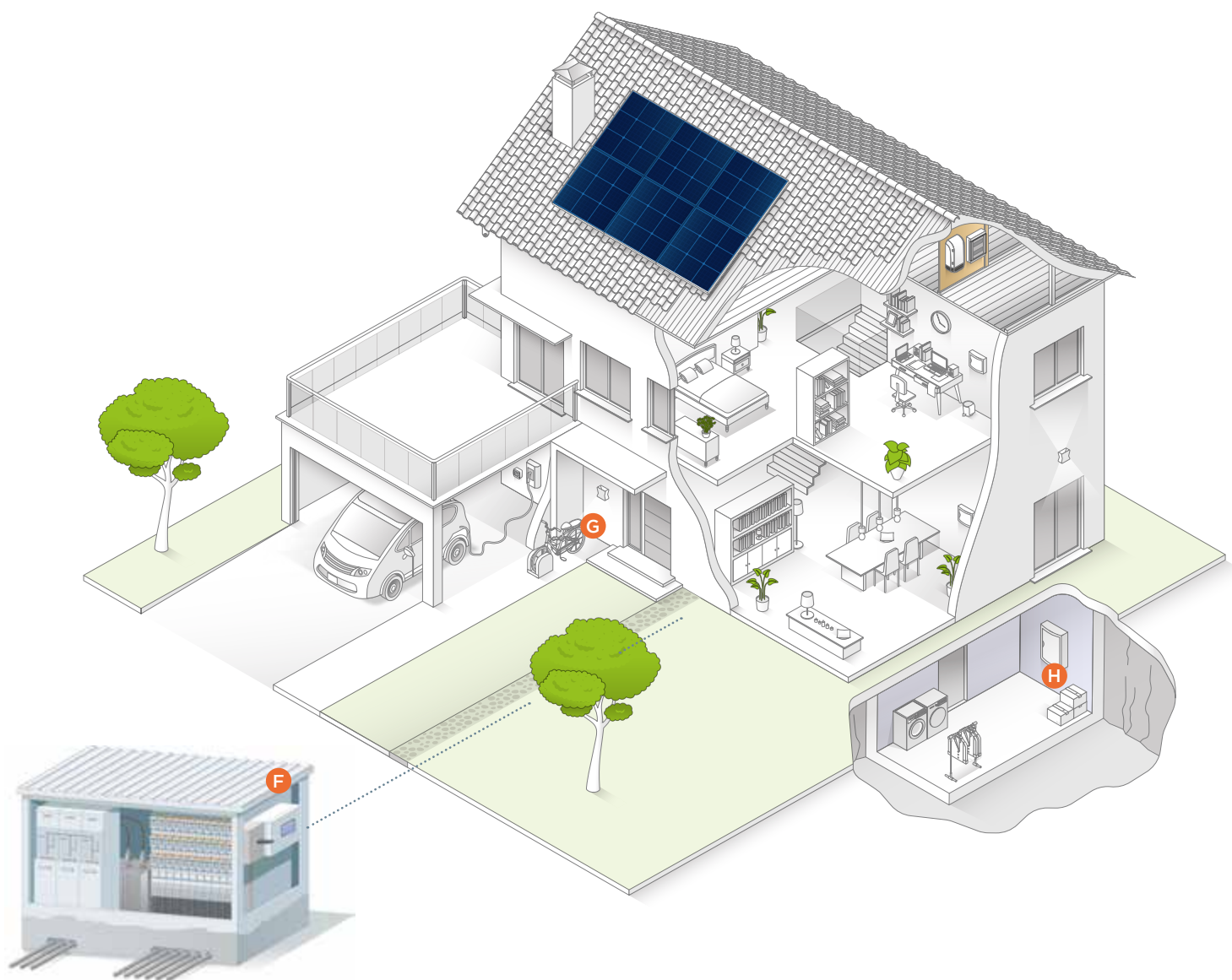

F

G

H



Feeder Pillar
BJU



House Service
BMF 100



Consumer Unit
BLD 30

Expertise in Power Protection

Mersen is a global expert in electrical power and advanced materials for high-tech industries. With more than 135 years of experience, the company is represented in over 50 industrial locations and 16 R&D centres in 35 countries.

Mersen Electrical Power offers a broad product portfolio in the area of electrical protection and control. Mersen offers solutions for power management applications, for the development and delivery of custom tailored solutions and key products for various key markets such as trade, industry, renewable energies, power electronics and eMobility. The teams at Mersen Electrical Power work together with customers around the world with Mersen's mission to make customer applications safer and more reliable.

Mersen is a world leader in fuse technology with a powerful presence in the circuit protection market, Mersen Electrical Protection Activity offers innovative solutions to enhance the safety of low voltage installations and equipment.

Above and beyond the supply of products, the company also provides added value in the form of technical support for OEMs, electrical contractors, panel builders, plant maintenance departments and utilities.

As a global player, Mersen has established production facilities on every continent to optimise the availability of products (France, Tunisia, United States, Canada, Mexico, India, Japan and China). All these locations are united around a global quality, safety and environment policy.

The world-class organisation of Mersen offers tried, tested and approved solutions ensuring the safety and integrity of our customers equipment protected devices and the safety of people working around them. Additionally guarding our customer's electrical equipment and installations over the long term, Mersen can offer the widest range of safe, reliable electrical and thermal protection solutions.

Mersen solutions are sold all over the world at over 4500 points of sale through professional distributors of electrical common equipment.

INDEX

HIGH QUALITY PROTECTION FOR INDUSTRIAL & RESIDENTIAL APPLICATIONS	
BS88 LV fuses and fuse holders	6
Range Mapping	8
Comparison Chart	9
Offset Bolted Tag Fuse Links (A-type)	10
Reference Data (415V)	10
Dimensions & Electrical characteristics (415V)	11
Reference Data (550V)	16
Dimensions & Electrical characteristics (550V)	17
Reference Data (690V)	20
Dimensions & Electrical characteristics (690V)	21
Offset Blade Fuse Links (F-type)	16
Reference Data (550V)	16
Dimensions & Electrical characteristics (550V)	17
Central Bolted Tag Fuse Links (B & C-type)	12
Reference Data (415V)	12
Dimensions & Electrical characteristics (415V)	13
Reference Data (690V)	22
Dimensions & Electrical characteristics (690V)	23
Time Vs Current Characteristics (415V) - A, B & C type	14
Time Vs Current Characteristics (415/550V) - A & F type	19
Time Vs Current Characteristics (690V) - A, B & C type	24
Cut-Off Current Characteristics for A, B & C types (415V)	15
Cut-Off Current Characteristics for A, B, C & F Types (550/690V)	25
I² t characteristics & Power Dissipation chart	26
Application Information	27
BS88 Fuse Holders	28
Mersen Fuse Holder Chart	29
Mersen profile & range mapping	34
CYLINDRICAL FUSES FOR STREET LIGHTING PROTECTION	
BLD/BMD/BLST Fuse Links	36
Cylindrical Type BLD Fuse Links	38
BLD time current / cut-off curve	39
BS Cylindrical Type BMD Fuse Links	40
BMD time current / cut-off curve	41
Offset Bolted Tag BLST Fuse Links	42
BLST time current / cut-off curve	43
LOW VOLTAGE DISTRIBUTION WIRING SYSTEMS	
Feeder Pillar Fuse Links	44
Feeder Pillar Fuse Links 415VAC 80kA	46
Feeder Pillar Fuse Links 415VAC 80kA time current / cut-off curve	48
Feeder Pillar Fuse Links 415VAC 33kA	49
Feeder Pillar Fuse Links 415VAC 33kA time current / cut-off curve	51
Comparison chart	55
Application information	53
Approvals	55

An aerial photograph of an industrial facility at dusk. Two tall, dark smokestacks rise from the complex, with wisps of white smoke or steam rising from their bases. The facility consists of numerous large, rectangular buildings with flat roofs. Some buildings have vertical light strips along their sides, and others have large glass windows that are illuminated from within. The sky is a deep blue with some light clouds, and a hint of sunset is visible on the right side. The overall scene is a mix of industrial and modern architectural elements.

HIGH QUALITY
PROTECTION
FOR INDUSTRIAL
& RESIDENTIAL
APPLICATIONS

BS88 LV FUSES AND FUSE HOLDERS

Mersen BS88 fuses UKCA and CE approved

Mersen's comprehensive range of BS88 low voltage fuses and fuse holders have been developed to answer today's demands in various industrial applications, including areas such as motor protection, utility, cable and device protection which with our high level performance fuses protect installations and keep people safe in residential and industrial buildings.

With proven experience in electrical protection, Mersen supports you in defining your needs according to your application. Furthermore, overcurrent protection for any low voltage electrical circuit is guaranteed by our design and manufacture.

Mersen provides you with high quality products in compliance with ISO 9001 standard.

All the circuit protection solutions shown in this catalogue are compliant with the RoHS European Directive. Mersen BS88 fuses are UKCA and CE approved.

For your own safety do NOT open BS88 fuse holders on load.

All items except those marked with * are ASTA 20 certified.



Range Mapping	8
Comparison Chart	9
Offset Bolted Tag Fuse Links (A-type)	10
Reference Data (415V)	10
Dimensions & Electrical characteristics (415V)	11
Reference Data (550V)	16
Dimensions & Electrical characteristics (550V)	17
Reference Data (690V)	20
Dimensions & Electrical characteristics (690V)	21
Offset Blade Fuse Links (F-type)	16
Reference Data (550V)	16
Dimensions & Electrical characteristics (550V)	17
Central Bolted Tag Fuse Links (B & C-type)	12
Reference Data (415V)	12
Dimensions & Electrical characteristics (415V)	13
Reference Data (690V)	22
Dimensions & Electrical characteristics (690V)	23
Time Vs Current Characteristics (415V) - A, B & C type	14
Time Vs Current Characteristics (415/550V) - A & F type	19
Time Vs Current Characteristics (690V) - A, B & C type	24
Cut-Off Current Characteristics for A, B & C types (415V)	15
Cut-Off Current Characteristics for A, B, C & F Types (550/690V)	25
I² t characteristics & Power Dissipation chart	26
Application Information	27
BS88 Fuse Holders	28
Mersen Fuse Holder Chart	29
Mersen profile & range mapping	34

RANGE MAPPING

BS TYPE	DESIGNATION	AC / DC	CATEGORY	CURRENT RATINGS
F1	BNS	550/250	gG	2, 4, 6, 10, 16, 20, 25, 32
			gM	10M16, 16M20, 20M25, 20M32, 25M32
		415	gM	20M36, 32M36, 32M40, 32M50, 32M63
F2	BES	550	gG	2, 4, 6, 10, 16, 20, 25, 32
		415	gG	36, 40, 50, 63
A1	BEIT	415/250	gG	36, 40, 50, 63
	BNIT	550/250	gG	2, 4, 6, 10, 16, 20, 25, 32
			gM	10M16, 16M20, 20M25, 20M32, 25M32
A2	BTIA	550/250	gG	2, 4, 6, 10, 16, 20, 25, 32
			gM	10M16, 16M20, 20M25, 20M32, 25M32
		690/460	gG	2, 4, 6, 10, 16, 20, 25, 32, 36, 40, 50, 63
			gM	10M16, 16M20, 20M25, 20M32, 25M32, 32M36, 32M40, 32M50, 32M63
A3	BTSS	415/240	gG	36, 40, 50, 63
	BTSDS	415/240	gG	80, 100, 125
			gM	63M80, 63M100, 80M100, 100M125
	BTIS	415/240	gG	36, 40, 50, 63, 80, 100, 125, 160
			gM	100M125, 100M160
		690/460	gG	36, 40, 50, 63
gM			32M36, 32M40, 32M50, 32M63	
A4	BTSD	415/240	gG	80, 100, 125
			gM	63M80, 63M100, 80M100, 100M125
	BTCP	415/240	gG	125, 160
			gM	100M125, 100M160, 100M200
		690/460	gG	36, 40, 50, 63, 80, 100
			gM	32M36, 32M40, 32M50, 32M63, 63M80, 63M100, 80M100
	BTFP	415/240	gG	125, 160, 200
			gM	200M250, 200M315
B1	BTBC	415/240	gG	32, 40, 50, 63
	BTSDC	415/240	gG	80, 100, 125
			gM	63M80, 63M100, 80M100, 100M125
	BTC	415/240	gG	125, 160
			gM	100M125, 100M160, 100M200
		690/460	gG	80, 100
gM			63M80, 63M100, 80M100	
B2	BTF	415/240	gG	125, 160, 200
			gM	200M250, 200M315
		690/460	gG	125, 160, 200
			gM	125M160, 125M200
B3	BTKF	415/240	gG	250, 315
		gM	315M400	
B3x	BTKM	415/240	gG	250, 315
B4	BTMF	415/240	gG	355, 400
		690/460	gG	250, 315, 355, 400
			gM	315M400
C1	BTM	415/240	gG	355, 400
		690/460	gG	250, 315, 355, 400
C2	BTM	415/240	gG	450, 500, 560, 630
		690	gG	450, 500, 560, 630
C3	BTLM	415/240	gG	670, 710, 750, 800
		690	gG	670, 710, 750, 800

COMPARISON CHART FOR BS88LV FUSE LINKS

COMPETITORS		MERSEN	BS TYPE REF.	RATINGS
NS-415V	NSD-550V	BNS55Vxx	F1	2-32A
ES-415V	-	BES42Vxx	F2	10-36A
-	ESD-550V	BES55Vxx	F2	40-63A
EIT-415V	-	BEIT42Vxx	A1	36-63A
NIT-415V	NITD-550V	BNIT55Vxx	A1	2-32A
TSA-415V	AA0-550V	BTIA55Vxx	A2C	2-32A
TIA-660V	H07-690V	BTIA69Vxx	A2	2-32A
TIS-660V	BA0-550V	BTIS69Vxx	A3	36-63A
TSS-415V	-	BTSS42Vxx	A3C	36-63A
TSDS-415V	-	BTSDS42Vxx	A3	80-125A
TSD-415V	-	BTSD42Vxx	A4C	80-125A
TCP-660V	L14-690V	BTCP69Vxxx	A4/A4C	36-100A
TSDC-415V	CD-415V	BTSDC42Vxxx	B1C	80-125A
TC-660V	L09-690V	BTC69Vxxx	B1	80-100A
TSFP-415V	DE0-415V	BTFP42Vxxx	A4xC	125-200A
TSF-415V	DD-415V	BTF42Vxxx	B2/B2C	125-200A
TFP-660V	M09-690V	BTF69Vxxx	B2	125-200A
TF-660V	M09-690V	BTF69Vxxx	B2	125-200A
TSK-415V	N09/P09-690V	BTMF69Vxxx	B4	250-400A
TKF-660V	N09/P09-690V	BTMF69Vxxx	B4	250-400A
TSMS-415V	P11-690V	BTM69Vxxx	C1	250-400A
TSM-415V	P11-690V	BTM69Vxxx	C1	250-400A
TM-660V	P11-690V	BTM69Vxxx	C1	250-400A
TSTS-415V	FF-550V	BTTM42Vxxx	C2	450-630A
TST-415V	FF-550V	BTTM42Vxxx	C2	450-630A
TTM-660V	FF-550V	BTTM69Vxxx	C2	450-630A
TSLS-415V	GF-550V	BTLM42Vxxx	C3	670-800A
TSL-415V	GF-550V	BTLM42Vxxx	C3	670-800A
TLM-660V	GF-550V	BTLM69Vxxx	C3	670-800A

OFFSET BOLTED TAG FUSE LINKS (A-TYPE)

Reference Data

Rated Voltage: 415 V ac Breaking Capacity: 80 kA
240/250 V dc Breaking Capacity: 40 kA

VOLTAGE (V) BS TYPE REF	RATING (A)	REFERENCE NUMBER	CATALOGUE NUMBER	BS TYPE REF	STD. PACK
415 V AC 240 V DC	36	M1045269	BTIS42V36	A3	10
	40	N1045270	BTIS42V40	A3	10
	50	P1045271	BTIS42V50	A3	10
	63	Q1045272	BTIS42V63	A3	10
	80	R1045273	BTIS42V80	A3	10
	100	S1045274	BTIS42V100	A3	10
415 V AC 240 V DC	125	L1019186	BTIS42V125	A3	10
	160	M1019187	BTIS42V160	A3	10
	100M125	N1019188	BTIS42V100M125	A3	10
	100M160	Q1019190	BTIS42V100M160	A3	10
415 V AC 240 V DC	80	Y1019197	BTSD42V80	A4C	10
	100	Z1019198	BTSD42V100	A4C	10
	125	A1019199	BTSD42V125	A4C	10
	63M80	B1019200	BTSD42V63M80	A4C	10
	63M100	C1019201	BTSD42V63M100	A4C	10
	80M100	X1054363	BTSD42V80M100*	A4C	10
	100M125	D1019202	BTSD42V100M125	A4C	10
415 V AC 240 V DC	36	T1045275	BTCP42V36	A4C	10
	40	Z1045280	BTCP42V40	A4C	10
	50	S1045297	BTCP42V50	A4C	10
	63	T1045298	BTCP42V63	A4C	10
	80	V1045299	BTCP42V80	A4C	10
	100	X1045301	BTCP42V100	A4C	10
415 V AC 240 V DC	125	W1019195	BTCP42V125	A4	10
	160	X1019196	BTCP42V160	A4	10
	100M125	A226297	BTCP42V100M125	A4C	10
	100M160	B226298	BTCP42V100M160	A4C	10
	100M200	C226299	BTCP42V100M200	A4C	5
415 V AC 240 V DC	125	D226300	BTFP42V125	A4XC	5
	160	E226301	BTFP42V160	A4XC	5
	200	F226302	BTFP42V200	A4XC	5
	200M250	G226303	BTFP42V200M250	A4X	5
	200M315	H226304	BTFP42V200M315	A4X	5
INDIAN MARKET ONLY					
415 V AC 250 V DC	36	A1019176	BEIT42V36	A1	10
	40	B1019177	BEIT42V40	A1	10
	50	C1019178	BEIT42V50	A1	10
	63	D1019179	BEIT42V63	A1	10
415 V AC 240 V DC	36	R1019191	BTSS42V36	A3C	10
	40	S1019192	BTSS42V40	A3C	10
	50	T1019193	BTSS42V50	A3C	10
	63	V1019194	BTSS42V63	A3C	10
415 V AC 240 V DC	80	E1019180J	BTSDS42V80	A3	10
	100	F1019181J	BTSDS42V100	A3	10
	125	G1019182J	BTSDS42V125	A3	10
	63M80	H1019183J	BTSDS42V63M80	A3	10
	63M100	J1019184J	BTSDS42V63M100	A3	10
	80M100	W1054362J	BTSDS42V80M100*	A3	10
	100M125	K1019185J	BTSDS42V100M125	A3	10



Note:

1. A3C, A4C represents compact dimensions with respect to BS88/ IEC60269 standards specified dimensions

2. A4X represents extended rating with respect to BS88 / IEC 60269 specified ratings

2. Note that items marked with an * are not ASTA certified

OFFSET BOLTED TAG FUSE LINKS (A-TYPE)

Dimensions

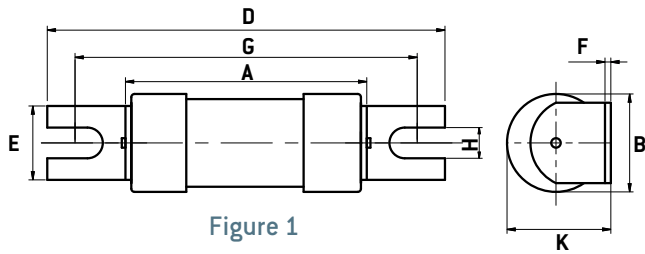

Figure 1

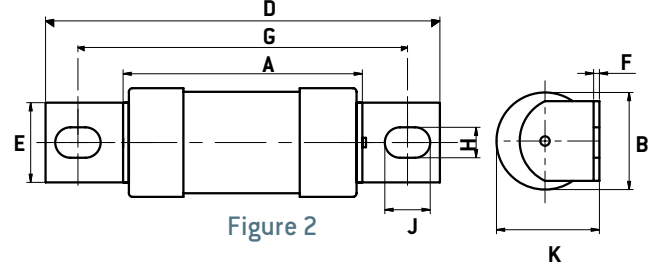

Figure 2

BS REF	FUSE TYPE (FIG. 1)	CURRENT RATING (A)	DIMENSIONS (MM)							
			A MAX	B MAX	D MAX	E MAX	F NOM	G NOM	H NOM	K MAX
A1	BEIT	36, 40, 50, 63	39.5	17.1	65.5	11	1.2	55	5.5	18.2
A3C	BTSS/BTIS	36, 40, 50, 63	38.8	17.1	84	9.2	1.2	73	5.2	18.5
A3	BTIS	125, 160, 100M125, 100M160	57	26.9	88.5	13	1.2	73	5.5	28

BS REF	FUSE TYPE (FIG. 2)	CURRENT RATING (A)	DIMENSIONS (MM)								
			A MAX	B MAX	D MAX	E MAX	F NOM	G NOM	H NOM	J NOM	K MAX
A3	BTSDS/BTIS	80, 100, 125, 63M80, 63M100, 80M100, 100M125	54.5	21	87	12.7	1.2	73	5.5	8	22.5
A4C	BTSD/BTCP	36, 40, 50, 63, 80, 100, 125, 63M80, 63M100, 80M100, 100M125	58.5	21	110	14.3	3.2	94	8.7	11	24.5
A4/ A4C	BTCP	125, 160, 100M125, 100M160	59.5	26.9	111	19.5	2.4	94	8.7	11	28.5
A4XC /A4C	BTFP/BTCP	125, 160, 200, 100M200	47	31	110	19	3.2	94	9	10	32
A4X	BTFP	200M250, 200M315	76	41.9	111	19.5	3.2	94	8.7	11	44

Electrical characteristics

FUSE TYPE	CURVE TYPE	CURRENT RATING (A)	I ² T (AMPERE ² SECONDS)		WATT LOSS
			PRE ARCING	TOTAL	
BEIT/BTSS/BTCP	gG	36	1000	4000	2.8
BEIT/BTSS/BTIS/BTCP	gG	40	1300	4200	3.0
BEIT/BTSS/BTIS/BTCP	gG	50	2600	8750	3.6
BEIT/BTSS/BTIS/BTCP	gG	63	4000	13900	4.7
BTSDS/BTSD/BTIS/BTCP	gG	80	8500	38250	6.5
BTSDS/BTSD	gM	63M80	8500	38250	5.1
BTSDS/BTSD/BTIS/BTCP	gG	100	14000	65000	7.5
BTSDS/BTSD	gM	63M100	14000	65000	4.7
BTSDS/BTSD	gM	80M100	14000	65000	6
BTSDS/BTSD	gG	125	16000	70000	11.5
BTIS/BTCP	gG	125	28000	78400	11.3
BTFP	gG	125	17000	70000	9.2
BTSDS/BTSD	gM	100M125	16000	70000	9.2
BTIS/BTCP	gM	100M125	28000	78400	9
BTIS/BTCP	gG	160	60000	168000	14.0
BTFP	gG	160	57000	150000	10.7
BTIS/BTCP	gM	100M160	60000	168000	8.8
BTFP	gG	200	105000	293000	16.2
BTCP	gM	100M200	105000	293000	8.1
BTFP	gM	200M250	190000	532000	19.2
BTFP	gM	200M315	270000	756000	19.7

CENTRAL BOLTED TAG FUSE LINKS (B & C-TYPE)

Reference Data

Rated Voltage: 415 V ac Breaking Capacity: 80 kA
240 V dc Breaking Capacity: 40 kA

VOLTAGE (V)	RATING (A)	REFERENCE NUMBER	CATALOGUE NUMBER	BS TYPE REF	STD. PACK
415 V AC 240 V DC	32	J226305	BTBC42V32	B1C	10
	40	K226306	BTBC42V40	B1C	10
	50	L226307	BTBC42V50	B1C	10
	63	M226308	BTBC42V63	B1C	10
415 V AC 240 V DC	80	Y1045302	BTC42V80	B1C	10
	100	Z1045303	BTC42V100	B1C	10
415 V AC 240 V DC	125	E1019203	BTC42V125	B1	10
	160	F1019204	BTC42V160	B1	10
	100M125	Q226311	BTC42V100M125	B1C	10
	100M160	R226312	BTC42V100M160	B1C	10
	100M200	S226313	BTC42V100M200	B1C	5
415 V AC 240 V DC	125	T226314	BTF42V125	B2C	5
	160	V226315	BTF42V160	B2C	5
	200	W226316	BTF42V200	B2C	5
	200M250	X226317	BTF42V200M250	B2	1
	200M315	Y226318	BTF42V200M315	B2	1
415 V AC 240 V DC	250	Z226319	BTKF42V250	B3	1
	315	A226320	BTKF42V315	B3	1
	315M400	B226321	BTKF42V315M400	B3	1
415 V AC 240 V DC	250	C226322	BTKM42V250	B3X	1
	315	D226323	BTKM42V315	B3X	1
415 V AC 240 V DC	355	E226324	BTMF42V355	B4	1
	400	F226325	BTMF42V400	B4	1
415 V AC 240 V DC	355	G226326	BTM42V355	C1	1
	400	H226327	BTM42V400	C1	1
415 V AC 240 V DC	450	J226328	BTTM42V450	C2	1
	500	K226329	BTTM42V500	C2	1
	560	L226330	BTTM42V560	C2	1
	630	M226331	BTTM42V630	C2	1
415 V AC 240 V DC	670	N226332	BTLM42V670	C3	1
	710	P226333	BTLM42V710	C3	1
	750	Q226334	BTLM42V750	C3	1
	800	R226335	BTLM42V800	C3	1
INDIAN MARKET ONLY					
415 V AC 240 V DC	80	G1019205	BTSDC42V80	B1C	10
	100	H1019206	BTSDC42V100	B1C	10
	125	J1019207	BTSDC42V125	B1C	10
	63M80	K1019208	BTSDC42V63M80	B1C	10
	63M100	L1019209	BTSDC42V63M100	B1C	10
	80M100	Y1054364	BTSDC42V80M100*	B1C	10
	100M125	M1019210	BTSDC42V100M125	B1C	10



Note:

1. B1C, B2C represents compact dimensions with respect to BS88 / IEC60269 standards specified dimensions

2. B3X represents extended rating with respect to BS88 / IEC 60269 specified ratings

2. Note that items marked with an * are not ASTA Certified

CENTRAL BOLTED TAG FUSE LINKS (B & C-TYPE)

Dimensions

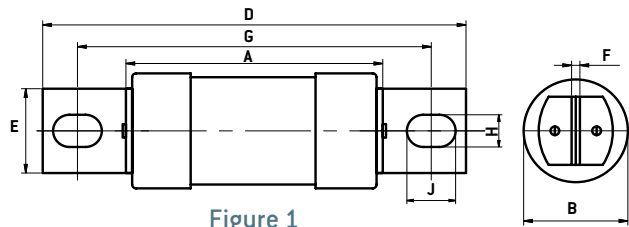

Figure 1

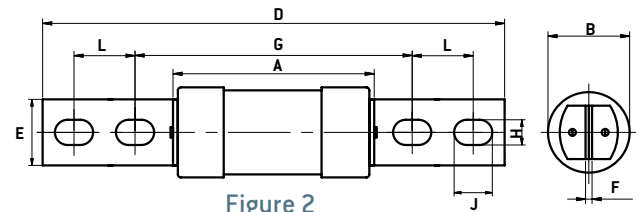

Figure 2

BS REF	FUSE TYPE	CURRENT RATING (A)	DIMENSIONS (MM)								
			A MAX	B MAX	D MAX	E MAX	F NOM	G NOM	H NOM	J NOM	LNOM
FIG. 1											
B1C	BTBC	32, 40, 50, 63	57	26.9	137	19.5	3.2	111	8.7	14	-
B1C	BTSDC/BTC	80, 100, 125, 63M80, 63M100, 80M100, 100M125	58.5	21	127	14.3	3.2	111	8.7	11.1	-
B1/B1C	BTC	125, 160, 100M125, 100M160	57	26.9	137	19.5	3.2	111	8.7	14	-
B1C/B2C	BTC/BTF	125, 160, 200, 100M200	47	31	136	19	3.2	111	9	12.5	-
B2/B3	BTF/BTKF	250, 315, 200M250, 200M315	73	41.9	138	19.5	3.2	111	8.7	14	-
B3X	BTKM	250, 315	73	41.9	159	26	3.2	133	10.3	14	-
B3	BTKF	250, 315, 315M400	75	59.1	138	26	4.8	111	8.7	14	-
B4	BTMF	355, 400	75	59.1	138	26	4.8	111	8.1	14	-
FIG. 2											
C1	BTM	355, 400	75	59.1	212	26	4.8	133	10.3	16	25.4
C2	BTTM	450, 500, 560, 630	83	74.4	212	26	6.3	133	10.3	16	25.4
C3	BTLM	670, 710, 750, 800	86	82.4	212	26	9.5	133	10.3	16	25.4

Electrical characteristics

FUSE TYPE	CURVE TYPE	CURRENT RATING (A)	I ² T (AMPERE ² SECONDS)		WATT LOSS
			PRE ARCING	TOTAL	
BTBC	gG	32	700	3000	3.6
BTBC	gG	40	1300	5850	4.0
BTBC	gG	50	2600	11700	4.8
BTBC	gG	63	4000	17500	5.9
BTSDC/BTIS	gG	80	8500	38250	6.5
BTSDC	gM	63M80	8500	38250	5.1
BTSDC/BTIS	gG	100	14000	65000	7.5
BTSDC	gM	63M100	14000	65000	4.7
BTSDC	gM	80M100	14000	65000	6
BTSDC	gG	125	16000	70000	11.5
BTC	gG	125	28000	78400	11.3
BTF	gG	125	17000	70000	9.2
BTSDC	gM	100M125	16000	70000	9.2
BTC	gM	100M125	28000	78400	9
BTC	gG	160	60000	168000	14.0
BTF	gG	160	57000	150000	10.7
BTC	gM	100M160	60000	168000	8.8
BTF	gG	200	105000	293000	16.2
BTC	gM	100M200	105000	293000	8.1
BTKF/BTKM	gG	250	190000	532000	24
BTF	gM	200M250	190000	532000	19.2
BTKF/BTKM	gG	315	270000	756000	31
BTF	gM	200M315	270000	756000	19.7
BTKF	gM	315M400	505000	1414000	30
BTMF/BTM	gG	355	395000	1106000	32
BTMF/BTM	gG	400	505000	1414000	38
BTTM	gG	450	650000	1820000	42
BTTM	gG	500	850000	2380000	48
BTTM	gG	560	1200000	3360000	50
BTTM	gG	630	1546000	4437000	54
BTLM	gG	670	1950000	5460000	60
BTLM	gG	710	2400000	6720000	62
BTLM	gG	750	3000000	8400000	65
BTLM	gG	800	3769000	10900000	68

TIME VS. CURRENT CHARACTERISTICS

gG Curves - 32 to 800A - 415 V ac

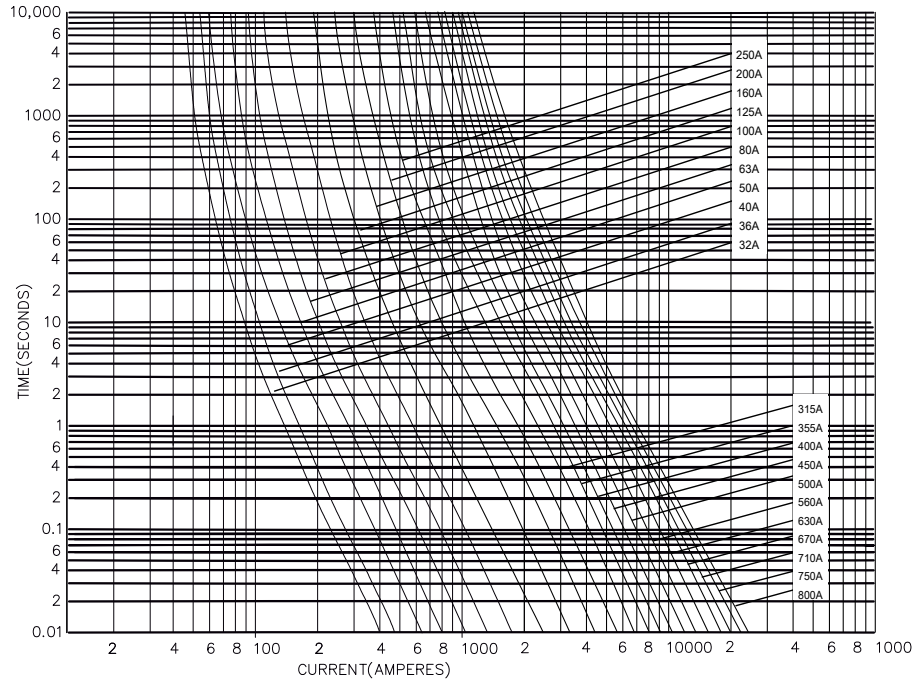

gM Curves - 63M80 to 315M400A - 415V ac

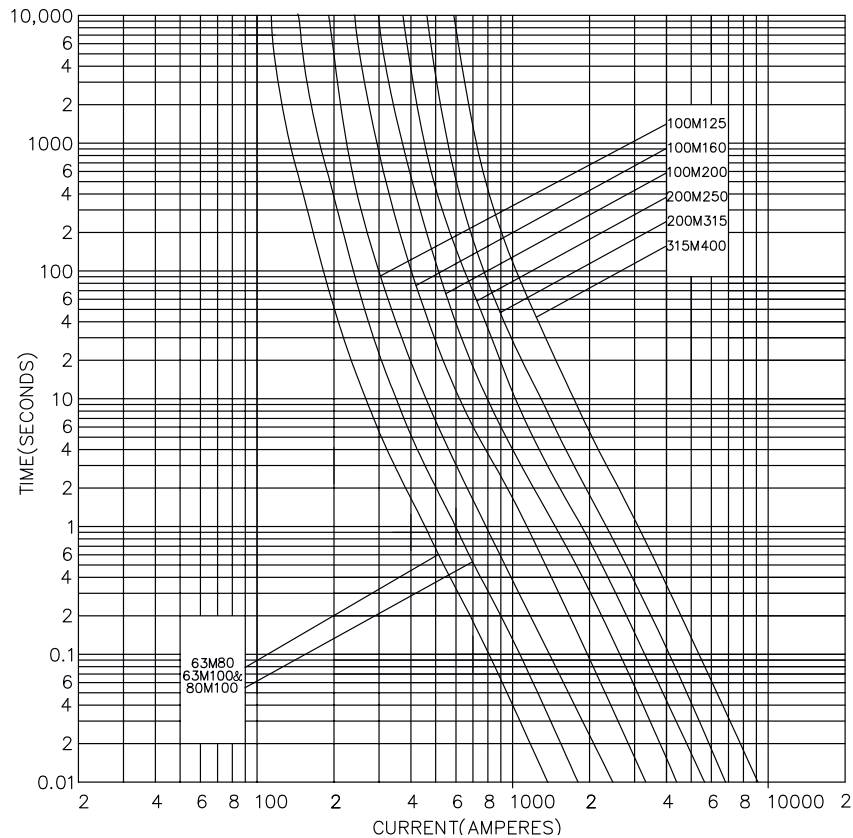

CUT-OFF CURRENT CHARACTERISTICS

A, B & C Type - 415 V ac

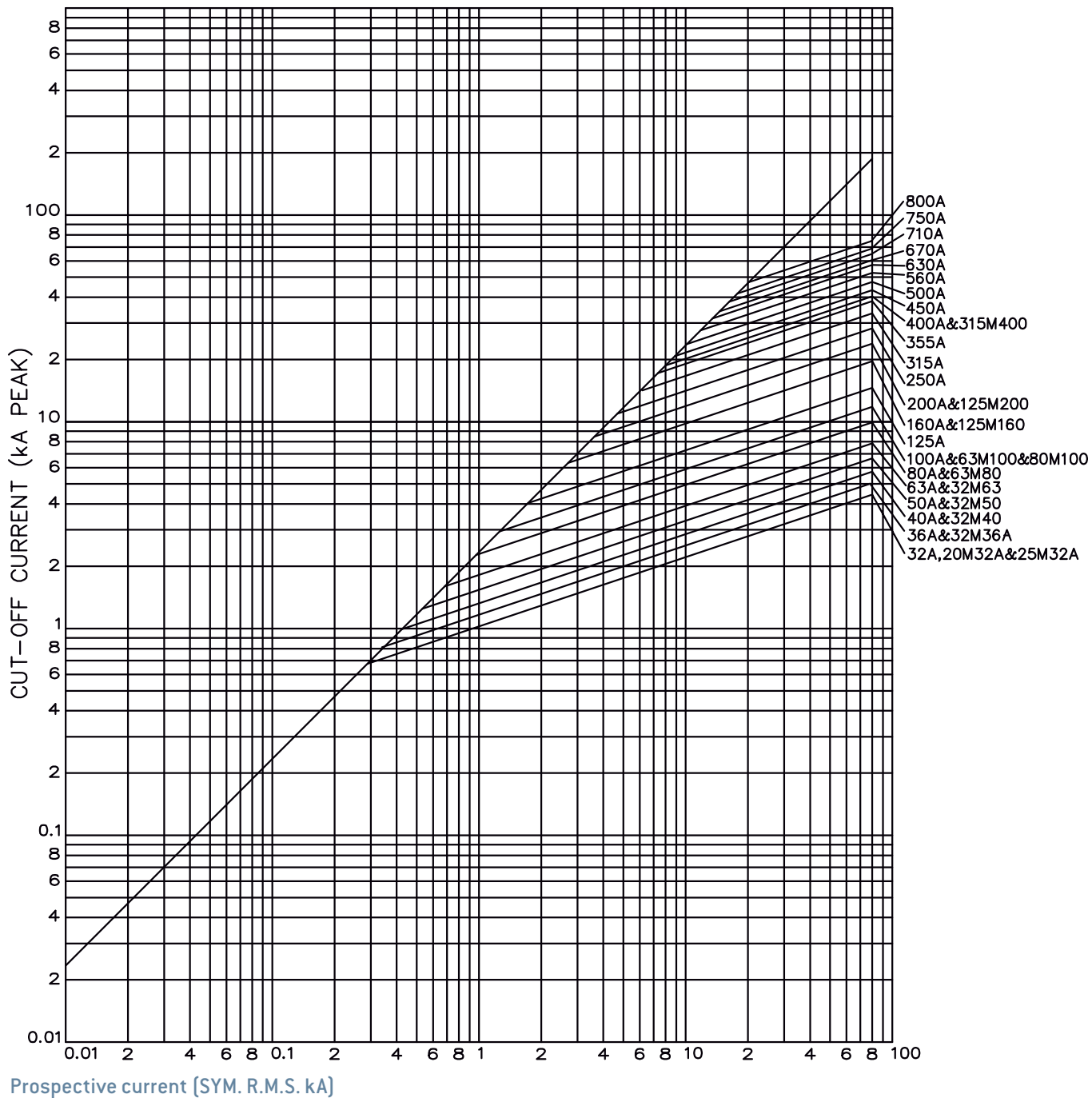

OFFSET BLADE/OFFSET TAG FUSE LINKS (F&A-TYPE)

Reference Data

Rated Voltage: 415/550 V ac Breaking Capacity: 80 kA
250 V dc Breaking Capacity: 40 kA

VOLTAGE (V)	RATING (A)	REFERENCE NO.	CATALOGUE NO.	BS TYPE REF	STD. PACK	
550 V AC 250 V DC	2	C1006643	BNS55V2	F1	10	
	4	D1006644	BNS55V4	F1	10	
	6	E1006645	BNS55V6	F1	10	
	10	N1019211	BNS55V10	F1	10	
	16	P1019212	BNS55V16	F1	10	
	20	Q1019213	BNS55V20	F1	10	
	25	R1019214	BNS55V25	F1	10	
	32	S1019215	BNS55V32	F1	10	
	10M16	T1019216	BS55V10M16	F1	10	
	16M20	V1019217	BNS55V16M20	F1	10	
	20M25	W1019218	BNS55V20M25	F1	10	
	20M32	X1019219	BNS55V20M32	F1	10	
25M32	Z1019221	BNS55V25M32	F1	10		
415 V AC	20M36	D1036981	BNS42V20M36*	F1	10	
	32M36	E1036982	BNS42V32M36*	F1	10	
	32M40	F1036983	BNS42V32M40*	F1	10	
	32M50	G1036984	BNS42V32M50*	F1	10	
	32M63	H1036985	BNS42V32M63*	F1	10	
550 V AC	2	Y1050799	BES55V2*	F2	10	
	4	Z1050800	BES55V4*	F2	10	
	6	A1050801	BES55V6*	F2	10	
	10	F1006646	BES55V10	F2	10	
	16	G1006647	BES55V16	F2	10	
	20	H1006648	BES55V20	F2	10	
	25	J1006649	BES55V25	F2	10	
	32	K1006650	BES55V32	F2	10	
415 V AC	36	L1006651	BES55V36	F2	10	
	40	J226351	BES42V40	F2	10	
	50	K226352	BES42V50	F2	10	
415 V AC	63	L226353	BES42V63	F2	10	
	550 V AC 250 V DC	2	E1006576	BNIT55V2	A1	10
		4	F1006577	BNIT55V4	A1	10
6		G1006578	BNIT55V6	A1	10	
10		B1019223	BNIT55V10	A1	10	
16		C1019224	BNIT55V16	A1	10	
20		D1019225	BNIT55V20	A1	10	
25		E1019226	BNIT55V25	A1	10	
32		F1019227	BNIT55V32	A1	10	
10M16		G1019228	BNIT55V10M16	A1	10	
16M20		H1019229	BNIT55V16M20	A1	10	
20M25		J1019230	BNIT55V20M25	A1	10	
20M32		K1019231	BNIT55V20M32	A1	10	
25M32	R1019237	BNIT55V25M32	A1	10		
550 V AC 250 V DC	2	S1019238	BTIA55V2	A2C	10	
	4	T1019239	BTIA55V4	A2C	10	
	6	V1019240	BTIA55V6	A2C	10	
	10	W1019241	BTIA55V10	A2C	10	
	16	X1019242	BTIA55V16	A2C	10	
	20	Y1019243	BTIA55V20	A2C	10	
	25	Z1019244	BTIA55V25	A2C	10	
	32	A1019245	BTIA55V32	A2C	10	
	10M16	B1019246	BTIA55V10M16	A2C	10	
	16M20	C1019247	BTIA55V16M20	A2C	10	
	20M25	D1019248	BTIA55V20M25	A2C	10	
	20M32	E1019249	BTIA55V20M32	A2C	10	
	25M32	F1019250	BTIA55V25M32	A2C	10	
	415 V AC 250 V DC	32M40	G226280	BTIA42V32M40	A2	10
		32M50	H226251	BTIA42V32M50	A2	10
32M63		K226283	BTIA42V32M63	A2	10	



Note:
1. A2C, represents compact dimensions with respect to BS88/ IEC60269 standards specified dimensions
2. Note that items marked with an * are not ASTA Certified

OFFSET BLADE/OFFSET TAG FUSE LINKS (F&A-TYPE)

Dimensions

Rated Voltage: 415/550 V ac Breaking Capacity: 80 kA

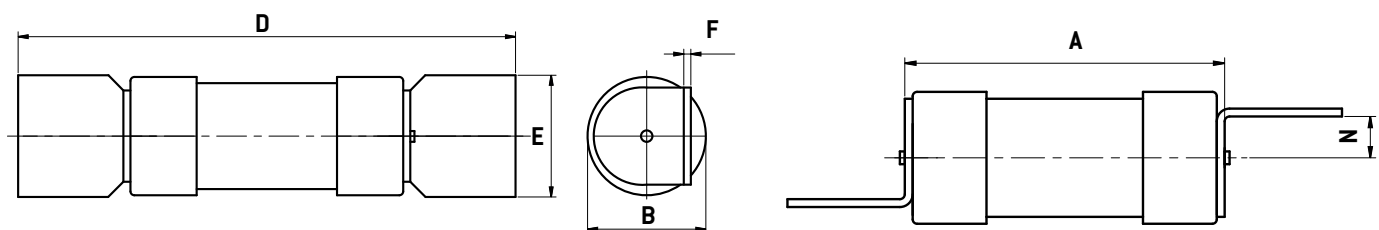

BS REF	FUSE TYPE	CURRENT RATING (A)	DIMENSIONS (MM)					
			A MAX	B MAX	D MAX	E MAX	F NOM	N NOM
F1	BNS	2, 4, 6, 10, 16, 20, 25, 32, 10M16, 16M20, 20M25, 20M32, 25M32	35.5	13.5	61	12.7	0.8	3.5
F1	BNS	20M36, 32M36, 32M40, 32M50, 32M63	35.5	17.1	61	12.7	0.8	3.5
F2	BES	2, 4, 6, 10, 16, 20, 25, 32, 36, 40, 50, 63	39.5	17.1	69	15.2	1.2	3.5

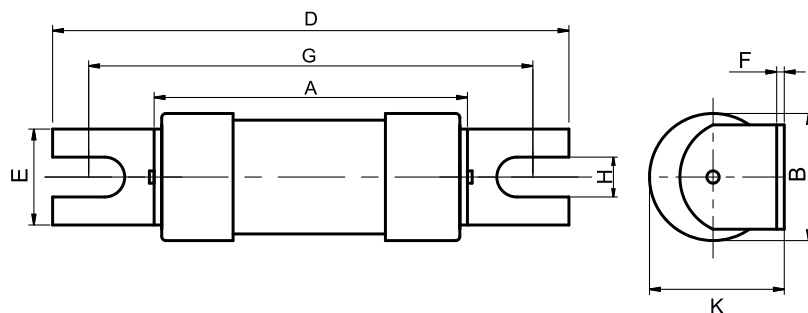

BS REF	FUSE TYPE	CURRENT RATING (A)	DIMENSIONS (MM)							
			A MAX	B MAX	D MAX	E MAX	F NOM	G NOM	H NOM	K MAX
A1	BNIT	2, 4, 6, 10, 16, 20, 25, 32, 10M16, 16M20, 20M25, 20M32, 25M32	35.5	13.5	56	11.2	0.8	44.5	4.8	14.5

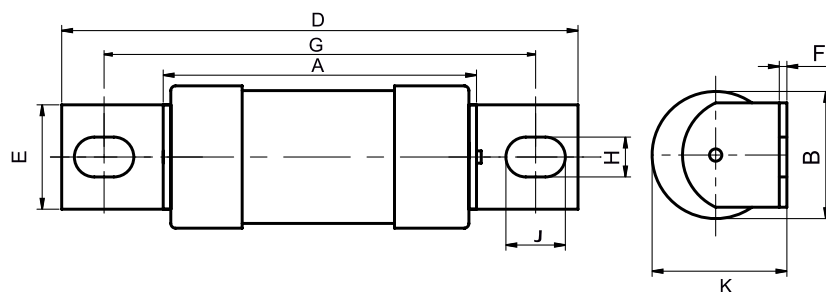

BS REF	FUSE TYPE	CURRENT RATING (A)	DIMENSIONS (MM)								
			A MAX	B MAX	D MAX	E MAX	F NOM	G NOM	H NOM	J MAX	K NOM
A2C	BTIA	2, 4, 6, 10, 16, 20, 25, 32, 10M16, 16M20, 20M25, 20M32, 25M32	35.5	13.5	86	9.2	0.8	73	8	5.5	14.5
A2	BTIA	32M40, 32M50, 32M63	56.5	21.9	86	9.2	1.2	73	8	5.5	23.5

OFFSET BLADE/OFFSET TAG FUSE LINKS (F&A-TYPE)

Electrical characteristics

FUSE TYPE	CURVE TYPE	CURRENT RATING (A)	I ² T (AMPERE ² SECONDS)		WATT LOSS
			PRE ARCING	TOTAL	
BNS/BNIT/BTIA	gG	2	1	5	0.9
BNS/BNIT/BTIA	gG	4	7.6	38	1.5
BNS/BNIT/BTIA	gG	6	28	40	1.8
BNS/BNIT/BTIA/BES	gG	10	70	350	1.2
BNS/BNIT/BTIA/BES	gG	16	120	550	1.6
BNS/BNIT/BTIA	gM	10M16	120	550	1
BNS/BNIT/BTIA/BES	gG	20	250	1250	1.7
BNS/BNIT/BTIA	gM	16M20	250	1250	1.36
BNS/BNIT/BTIA/BES	gG	25	420	2100	2
BNS/BNIT/BTIA	gM	20M25	420	2100	1.6
BNS/BNIT/BTIA/BES	gG	32	670	3350	2.9
BNS/BNIT/BTIA	gM	20M32	670	3350	1.8
BNS/BNIT/BTIA	gM	25M32	670	3350	2.3
BNS/BES	gG	36	700	4000	2.8
BNS	gM	20M36	700	4000	1.6
BNS/BES	gG	40	1300	4200	3
BNS	gM	32M40	1300	4200	2.4
BNS/BES	gG	50	2600	8750	3.6
BNS	gM	32M50	2600	8750	2.3
BNS/BES	gG	63	4000	13900	4.7
BNS	gM	32M63	4000	13900	2.4

TIME VS. CURRENT CHARACTERISTICS

gG Curve-2 to 63A - 415/550 V ac

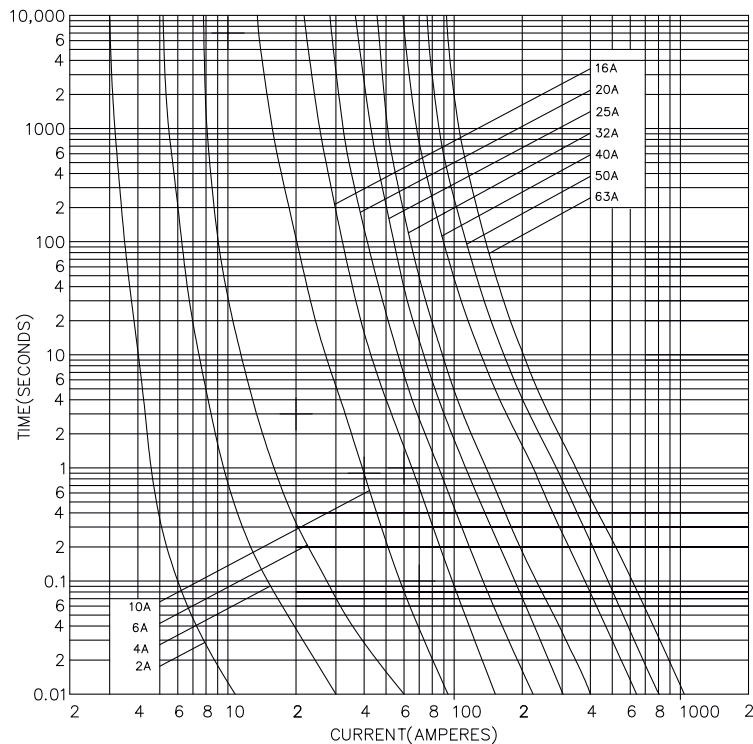

gM Curve-10M16 to 32M63-415/550 V ac

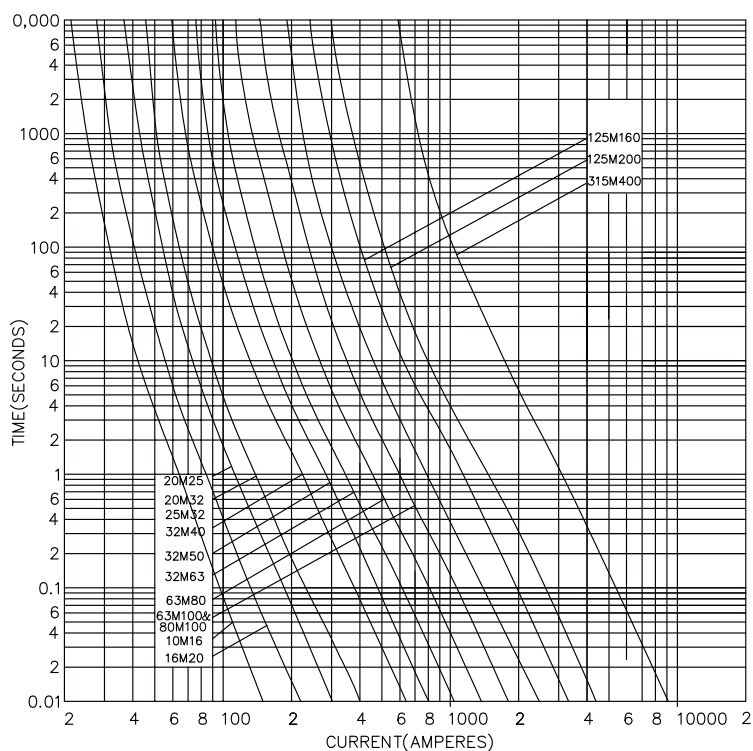

OFFSET BOLTED TAG FUSE LINKS (A-TYPE)

Reference Data

Rated Voltage: 690 V ac Breaking Capacity: 80 kA
460 V dc Breaking Capacity: 40 kA

VOLTAGE (V)	RATING (A)	REFERENCE NUMBER	CATALOGUE NUMBER	BS TYPE REF	STD. PACK
690 V AC 460 V DC	2	G1019251	BTIA69V2	A2	10
	4	H1019252	BTIA69V4	A2	10
	6	J1019253	BTIA69V6	A2	10
	10	K1019254	BTIA69V10	A2	10
	16	L1019255	BTIA69V16	A2	10
	20	M1019256	BTIA69V20	A2	10
	25	N1019257	BTIA69V25	A2	10
	32	P1019258	BTIA69V32	A2	10
	10M16	A1019751	BTIA69V10M16	A2	10
	16M20	B1019752	BTIA69V16M20	A2	10
	20M25	Q1019259	BTIA69V20M25	A2	10
	20M32	R1019260	BTIA69V20M32	A2	10
	25M32	C1019753	BTIA69V25M32	A2	10
	36	S1019261	BTIA69V36	A2	10
	40	T1019262	BTIA69V40	A2	10
	50	V1019263	BTIA69V50	A2	10
	690 V AC 460 V DC	63	W1019264	BTIA69V63	A2
32M36		A1019268	BTIA69V32M36	A2	10
32M40		X1019265	BTIA69V32M40	A2	10
32M50		Y1019266	BTIA69V32M50	A2	10
32M63		Z1019267	BTIA69V32M63	A2	10
36		N1006584	BTIS69V36	A3	10
40		P1006585	BTIS69V40	A3	10
50		Q1006586	BTIS69V50	A3	10
690 V AC 460 V DC	63	R1006587	BTIS69V63	A3	10
	32M36	C1019270	BTIS69V32M36	A3	10
	32M40	D1006598	BTIS69V32M40	A3	10
	32M50	E1006599	BTIS69V32M50	A3	10
	32M63	F1006600	BTIS69V32M63	A3	10
	36	H1019275	BTCP69V36	A4C	10
	40	M1006606	BTCP69V40	A4C	10
	50	N1006607	BTCP69V50	A4C	10
690 V AC 460 V DC	63	J1019276	BTCP69V63	A4C	10
	32M36	K1019277	BTCP69V32M36	A4C	10
	32M40	L1019278	BTCP69V32M40	A4C	10
	32M50	M1019279	BTCP69V32M50	A4C	10
	32M63	N1019280	BTCP69V32M63	A4C	10
	80	S1006611	BTCP69V80	A4	10
	100	T1006612	BTCP69V100	A4	10
	63M80	V1006613	BTCP69V63M80	A4	10
	63M100	W1006614	BTCP69V63M100	A4	10
	80M100	Z1054365	BTCP69V80M100*	A4	10



Note:

1. A4C represents compact dimensions with respect to BS88/ IEC60269 standards specified dimensions

2. Note that items marked with an * are not ASTA Certified

OFFSET BOLTED TAG FUSE LINKS (A-TYPE)

Dimensions

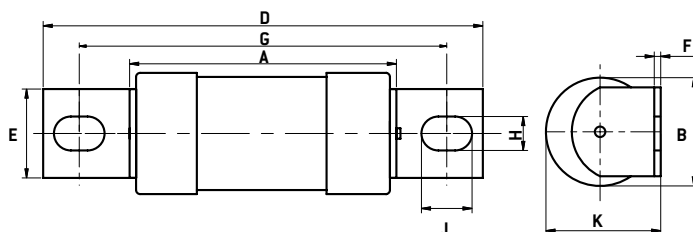

BS REF	FUSE TYPE	CURRENT RATING (A)	DIMENSIONS (MM)								
			A MAX	B MAX	D MAX	E MAX	F NOM	G NOM	H NOM	J NOM	K MAX
A2	BTIA	2, 4, 6, 10, 16, 20, 25, 32, 10M16, 16M20, 20M25, 20M32, 25M32	56.5	21.9	86	9.2	1.2	73	8	5.5	23.5
A2	BTIA	36, 40, 50, 63, 32M36, 32M40, 32M50, 32M63	54.5	21	86	8.7	1.2	73	8	5.5	22.3
A3	BTIS	36, 40, 50, 63, 32M36, 32M40, 32M50, 32M63	54.5	21	87	12.7	1.2	73	8	5.5	22.5
A4C	BTCP	36, 40, 50, 63, 32M36, 32M40, 32M50, 32M63	57.5	21	109	14.3	3.2	94	11	8.7	22.3
A4	BTCP	80, 100, 63M80, 63M100, 80M100	59.5	26.9	111	19.5	2.4	94	11	8.7	28.5

Electrical characteristics

FUSE TYPE	CURVE TYPE	CURRENT RATING (A)	I ² T (AMPERE ² SECONDS)		WATT LOSS
			PRE ARCING	TOTAL	
BTIA	gG	2	1	6.5	0.8
BTIA	gG	4	7.6	50	1.4
BTIA	gG	6	28	180	1.7
BTIA	gG	10	70	380	1.2
BTIA	gG	16	120	580	1.6
BTIA	gM	10M16	120	580	1
BTIA	gG	20	250	1450	1.7
BTIA	gM	16M20	250	1450	1.4
BTIA	gG	25	420	2500	2.0
BTIA	gM	20M25	420	2500	1.6
BTIA	gG	32	670	3900	2.9
BTIA	gM	20M32	670	3900	1.8
BTIA	gM	25M32	670	3900	2.3
BTIA/BTIS/BTCP	gG	36	700	4500	3.8
BTIA/BTIS/BTCP	gM	32M36	700	4500	3.4
BTIA/BTIS/BTCP	gG	40	1300	7400	4.0
BTIA/BTIS/BTCP	gM	32M40	1300	7400	3.2
BTIA/BTIS/BTCP	gG	50	2600	15000	4.8
BTIA/BTIS/BTCP	gM	32M50	2600	15000	3
BTIA/BTIS/BTCP	gG	63	4000	23000	5.9
BTIA/BTIS/BTCP	gM	32M63	4000	23000	3
BTCP	gG	80	8500	48500	6.5
BTCP	gM	63M80	8500	48500	5.1
BTCP	gG	100	14000	80000	7.5
BTCP	gM	63M100	14000	80000	4.7
BTCP	gM	80M100	14000	80000	6

CENTRAL BOLTED TAG FUSE LINKS (B&C-TYPE)

Reference Data

Rated Voltage: 690 V ac Breaking Capacity: 80 kA
460 V dc Breaking Capacity: 40 kA

VOLTAGE (V)	RATING (A)	REFERENCE NUMBER	CATALOGUE NUMBER	BS TYPE REF	STD. PACK
690 V AC 460 V DC	80	B1019775J	BTC69V80	B1	10
	100	A1006618J	BTC69V100	B1	10
	63M80	B1006619J	BTC69V63M80	B1	10
	63M100	C1006620J	BTC69V63M100	B1	10
	80M100	A1054366J	BTC69V80M100*	B1	10
690 V AC 460 V DC	125	D1006621E	BTF69V125	B2	5
	160	E1006622E	BTF69V160	B2	5
	200	F1006623E	BTF69V200	B2	5
	125M160	G1006624E	BTF69V125M160	B2	5
	125M200	H1006625E	BTF69V125M200	B2	5
690 V AC 460 V DC	250	P1036991A	BTKF69V250	B3	1
	315	Q1036992A	BTKF69V315	B3	1
690 V AC 460 V DC	250	J1006626A	BTMF69V250	B4	1
	315	K1006627A	BTMF69V315	B4	1
	355	L1006628A	BTMF69V355	B4	1
	400	M1006629A	BTMF69V400	B4	1
	315M400	N1006630A	BTMF69V315M400	B4	1
690 V AC 460 V DC	250	P1006631A	BTM69V250	C1	1
	315	R1006633A	BTM69V315	C1	1
	355	S1006634A	BTM69V355	C1	1
	400	W1006637A	BTM69V400	C1	1
690 V AC	450	Y1006639A	BTTM69V450	C2	1
	500	Z1006640A	BTTM69V500	C2	1
	560	A1006641A	BTTM69V560	C2	1
	630	B1006642A	BTTM69V630	C2	1
690 V AC	670	D1019271A	BTLM69V670	C3	1
	710	E1019272A	BTLM69V710	C3	1
	750	F1019273A	BTLM69V750	C3	1
	800	G1019274A	BTLM69V800	C3	1



Note:

1. Note that items marked with an * are not ASTA Certified.

CENTRAL BOLTED TAG FUSE LINKS (B&C-TYPE)

Dimensions

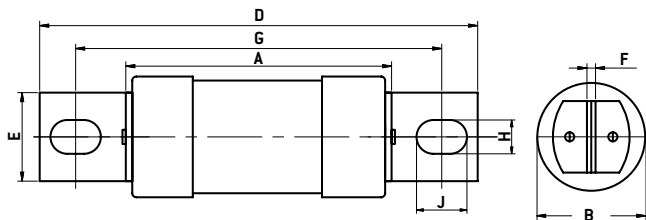

BS REF	FUSE TYPE	CURRENT RATING (A)	DIMENSIONS (MM)							
			A MAX	B MAX	D MAX	E MAX	F NOM	G NOM	H NOM	J NOM
B1	BTC	80, 100, 63M80, 63M100, 80M100	57	26.9	137	19.5	3.2	111	8.7	14
B2	BTF	125, 160, 200, 125M160, 125M200	73	41.9	138	19.5	3.2	111	8.7	14
B3	BTKF	250, 315	73	41.9	138	19.5	3.2	111	8.7	14
B4	BTMF	250, 315, 355, 400, 315M400	75	59.1	138	26	4.8	111	8.7	14

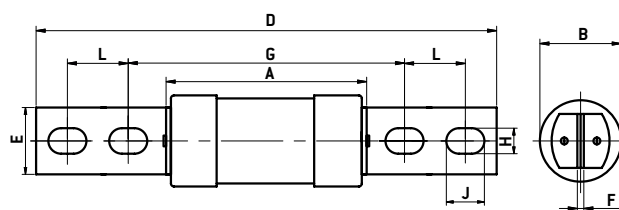

BS REF	FUSE TYPE	CURRENT RATING (A)	DIMENSIONS (MM)								
			A MAX	B MAX	D MAX	E MAX	F NOM	G NOM	H NOM	J NOM	L NOM
C1	BTM	250, 315, 355, 400	75	59.1	212	26	4.8	133	10.3	16	25.4
C2	BTTM	450, 500, 560, 630	83	74.4	212	26	6.3	133	10.3	16	25.4
C3	BTLM	670, 710, 750, 800	86	82.4	212	26	9.5	133	10.3	16	25.4

Electrical characteristics

FUSE TYPE	CURVE TYPE	CURRENT RATING (A)	I ² T (AMPERE ² SECONDS)		WATT LOSS
			PRE ARCING	TOTAL	
BTC	gG	80	8500	48500	6.5
BTC	gM	63M80	8500	48500	5.1
BTC	gG	100	14000	80000	7.5
BTC	gM	63M100	14000	80000	4.7
BTC	gM	80M100	14000	80000	6
BTF	gG	125	28000	140000	11.3
BTF	gG	160	60000	300000	14.5
BTF	gM	125M160	60000	300000	11.3
BTF	gG	200	105000	350000	16.2
BTF	gM	125M200	105000	350000	10.1
BTMF/BTM/BTKF	gG	250	190000	700000	24
BTMF/BTM/BTKF	gG	315	270000	1350000	31
BTMF/BTM	gG	355	395000	1975000	32
BTMF/BTM	gG	400	505000	2525000	38
BTMF	gM	315M400	505000	2525000	30
BTTM	gG	450	650000	3300000	42
BTTM	gG	500	850000	4250000	48
BTTM	gG	560	1200000	5800000	50
BTTM	gG	630	1546000	9800000	54
BTLM	gG	670	1950000	10100000	60
BTLM	gG	710	2400000	12000000	62
BTLM	gG	750	3000000	14200000	65
BTLM	gG	800	3769000	15000000	68

TIME VS. CURRENT CHARACTERISTICS

gG Curves - 2 to 800A - 690 V ac

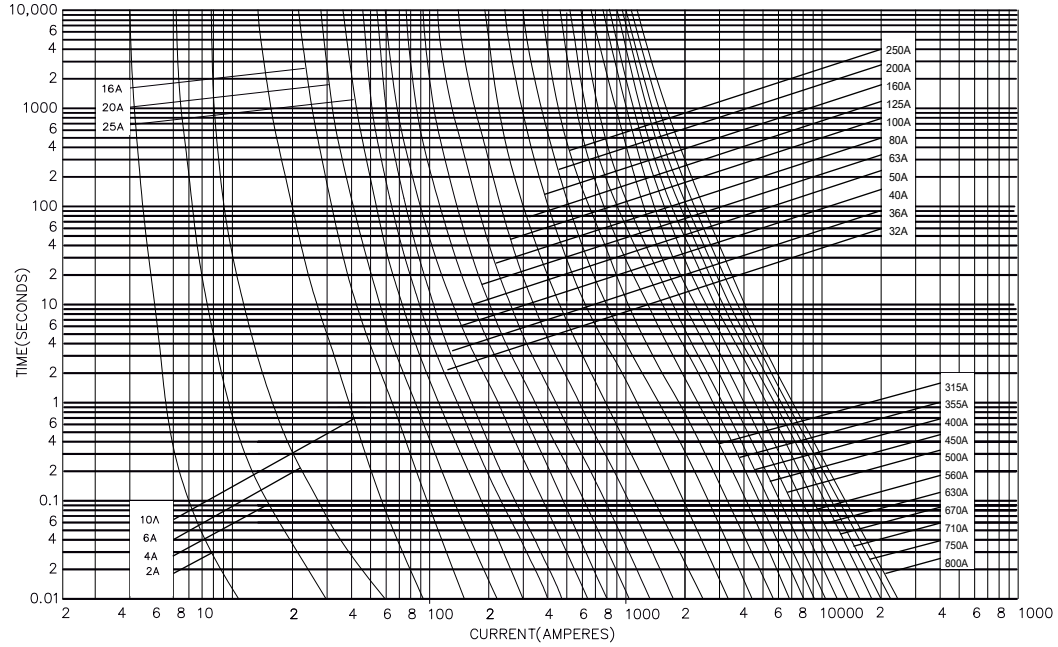

gM Curves - 10M16 to 315M400A - 690 V ac

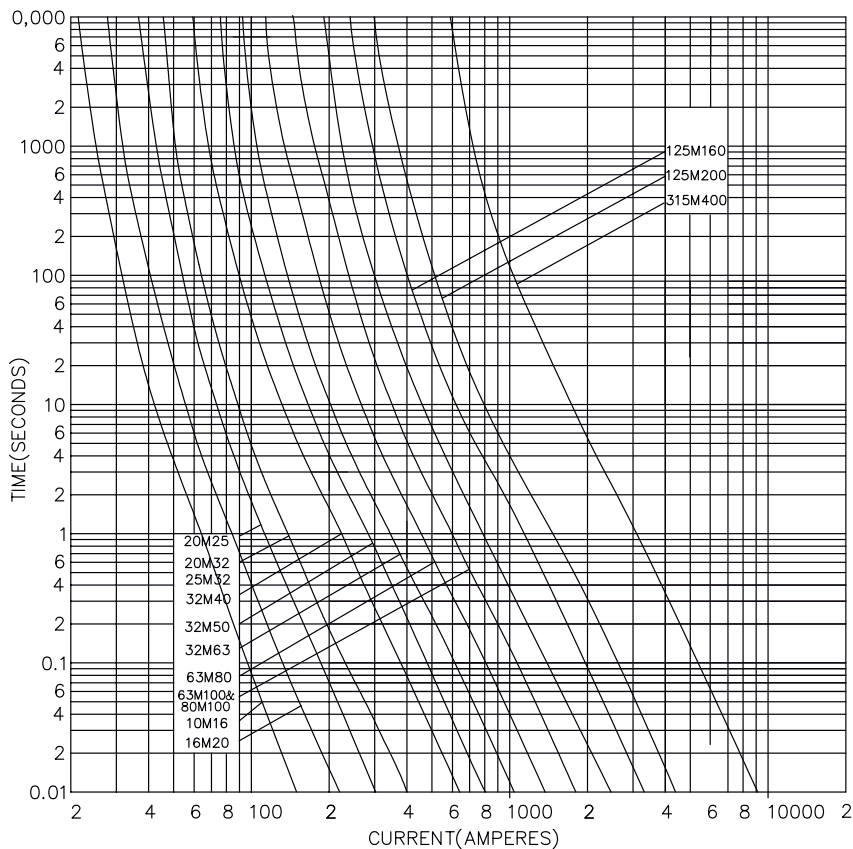

CUT-OFF CURRENT CHARACTERISTICS

A, B, C, & F - Type 550/690 V ac

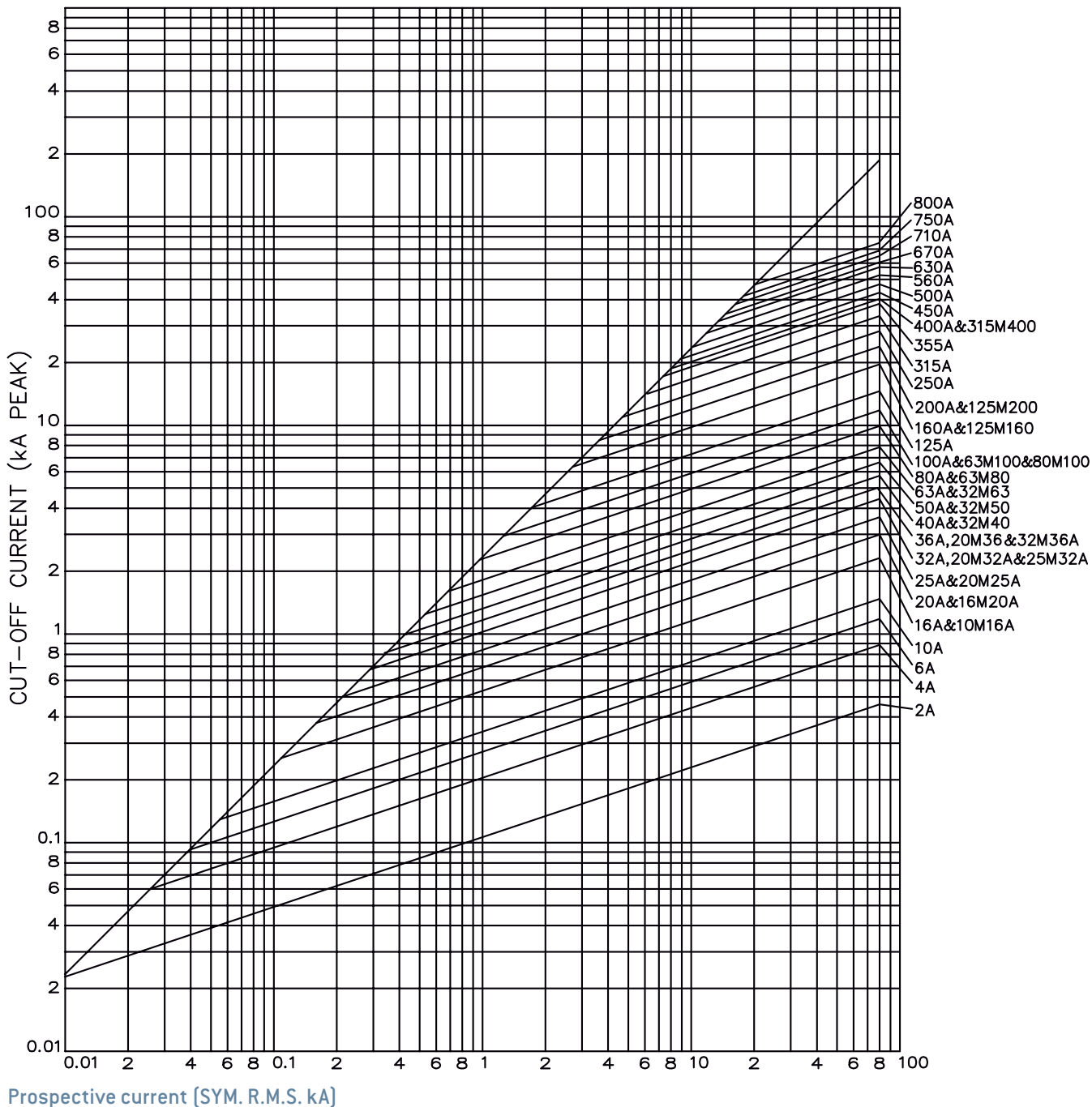

I²T CHARACTERISTICS

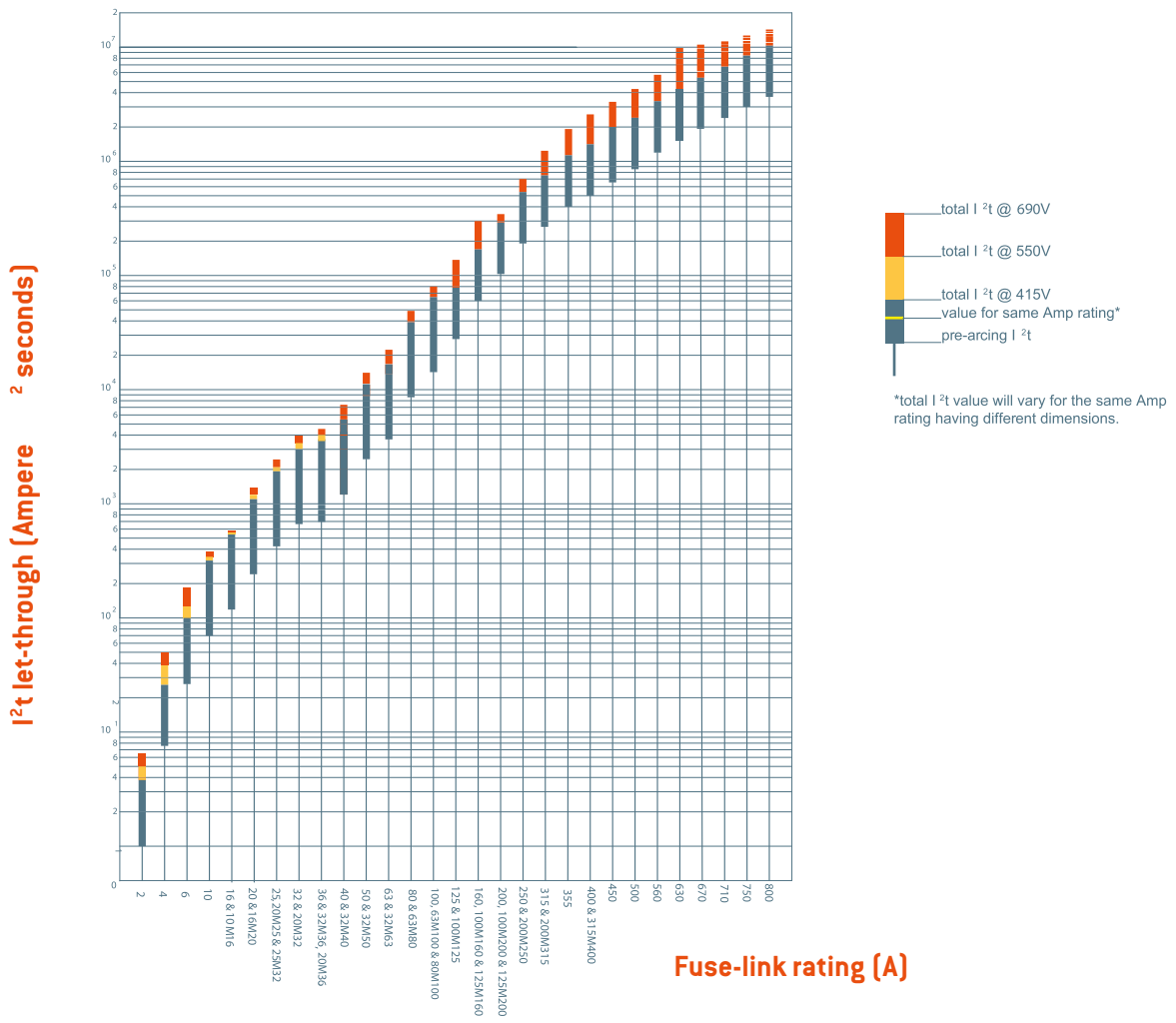

Power dissipation chart

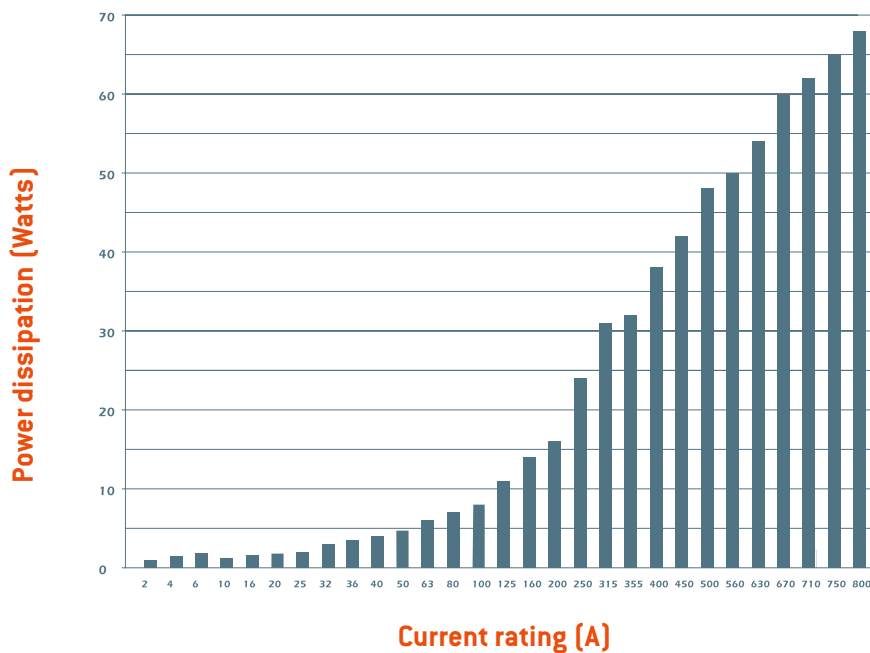

APPLICATION INFORMATION

Voltage rating selection

BS88 fuses comply with IEC 60269 standards. They are tested under a voltage at least 10% higher than the fuse rated voltage.

Ambient temperature

Above an ambient of 40°C a general de-rating of 0.5% of the fuse-link rated current per excess degree centigrade is recommended.

Cable protection

gG fuses protect cables against both overload and short circuit. The cable is protected when the following conditions are fulfilled.

$$I_B \leq I_N \leq I_z$$

$$I_F \leq 1.45I_z$$

I_B : Operating current of the cable

I_z : Maximum current carrying capacity of the cable

I_N : Rated current of the fuse

I_F : Conventional fusing current of the fuse

Capacitor circuit protection

The fuse selection must take into account:

- The inrush current occurring when the capacitor is switched on.
- The harmonic currents during the normal operation of the network.
- Capacitor tolerances.

The fuse link should be chosen with a current rating greater than 1.7 times the rated capacitor current. Correction for ambient temperature higher than 40°C must be added.

Transformer protection

Fuses must be fitted both in the primary and the secondary of the transformer. The fuse selection must take into account the high transient inrush current in the primary of the transformer. Consequently the normal current rating of the fuse links on the primary side of transformers should be at least twice the nominal transformer primary current. The normal I_n value of the fuse links on the secondary side of transformers is at least equal to the nominal transformer secondary current when the temperature does not exceed 40°C.

Motor circuit protection

The motor starter manufacturers generally recommend the fuse link rating to be used in conjunction with the motor starter. Type 2 co-ordination is easily obtained with Mersen fuses in view of having the pre-arcing I^2t values closer to the lower limit of the specified limits of the standard. The gM fuse selection as for an aM fuse requires the melt current at 5 seconds is 7 times the fuse rating.

Protection against electrical shock

The rule is to disconnect within a time specified by local standards. Generally wiring regulations require a disconnecting time not exceeding 5 seconds for a distribution circuit. It will be less than 1 second in many other cases. The maximum value of each fault loop impedance (Z_s) for gG fuse link for BS88: part 2 & 6 are as shown at 240V.

RATING (A)	Z_s (OHMS)
2	40.00
4	20.00
6	15.00
10	8.00
16	4.90
20	3.48
25	2.67
32	2.18
36	1.85
40	1.60
50	1.26
63	0.93
80	0.68
100	0.48
125	0.43
160	0.29
200	0.22
250	0.171
315	0.137
355	0.126
400	0.114
450	0.100
500	0.086
560	0.077
630	0.071
670	0.063
710	0.056
750	0.053
800	0.050

BS88 FUSE HOLDERS & NEUTRAL LINK

For Offset Blade & Bolted Tag Fuse Links

For Offset Blade & Bolted Tag Fuse Links

Fuse holders from Mersen comply with BS88-1 and BS88-6: 1988. The fuse holders are designed to prevent direct contact with live parts when being inserted or removed, preventing any likelihood of inadvertent contact with live metal. Also, cable terminals within the fuse base are fully shrouded when holder is removed (product is IP2X Classified).

Solid Neutral link

PART NUMBER	VOLTAGE	E1 PACK SIZE	NOMINAL CURRENT (A)	E1 CAT NUMBER
D239134	550	10	32	BNEUTRALF1
E239135	550	10	63	BNEUTRALF2
F239136	550	10	32	BNEUTRALA1
G239137	690	10	32	BNEUTRALA2
H239138	690	10	63	BNEUTRALA3
J239139	690	10	125	BNEUTRALA4
Q1065581	690	5	200	BNEUTRALB2
R1065582	690	5	400	BNEUTRALB4
T1065584	690	5	800	BNEUTRALC3
S1065583	690	5	400	BNEUTRALC1

Type Of Connection



BFF Front wire connected
(front-front) 3 connection styles possible: Mounting on board with cable upstream and downstream



BBB Back stud connected
(back-back) Mounting on board with two cables on the back (connection via lug, see table)



BFB Front Back (busbar) stud connected Mounting on board with upstream or downstream cable and back cable

Advantages

1. DIN Rail Mounting for ease of assembly
2. Safety Shrouds
3. Options for colour and terminations
4. RoHs compliance



BS88 FUSE HOLDERS & NEUTRAL LINK

For Offset Blade & Bolted Tag Fuse Links

TYPE	VOLTAGE RATING (V)	NOMINAL CURRENT (A)	COLOUR	CONNECTION	REFERENCE NUMBER	CATALOGUE NUMBER	STANDARD PACK	MERSEN FUSE/NEUTRAL LINK TYPE
F1	550	32	Black	Front-Front	A230138	BFF32F1	6	BNS55Vxx
F1	550	32	Black	Back-Back	N239120	BBB32F1	6	
F1	550	32	Black	Front-Back	B230139	BFB32F1	6	
F1	550	32	Green	Front-Front	B1012553	BFF32F1G	6	
F1	550	32	Green	Back-Back	V1012547	BBB32F1G	6	
F1	550	32	Green	Front-Back	Y1012550	BFB32F1G	6	
F1	550	32	White	Front-Front	P239121	BFF32F1W	6	BNEUTRALF1
F1	550	32	White	Back-Back	Q239122	BBB32F1W	6	
F1	550	32	White	Front-Back	R239123	BFB32F1W	6	BES55Vxx BES42Vxx
F2	550	63	Black	Front-Front	S239124	BFF63F2	6	
F2	550	63	Black	Back-Back	T239125	BBB63F2	6	
F2	550	63	Black	Front-Back	V239126	BFB63F2	6	
F2	550	63	Green	Front-Front	Z239130	BFF63F2G	6	
F2	550	63	Green	Back-Back	A239131	BBB63F2G	6	
F2	550	63	Green	Front-Back	B239132	BFB63F2G	6	BNEUTRALF2
F2	550	63	White	Front-Front	W239127	BFF63F2W	6	
F2	550	63	White	Back-Back	X239128	BBB63F2W	6	
F2	550	63	White	Front-Back	Y239129	BFB63F2W	6	
A1	550	32	Black	Front-Front	D239088	BFF32A1	6	BNIT55Vxx
A1	550	32	Black	Back-Back	E239089	BBB32A1	6	
A1	550	32	Black	Front-Back	F239090	BFB32A1	6	
A1	550	32	Green	Front-Front	K239094	BFF32A1G	6	
A1	550	32	Green	Back-Back	L239095	BBB32A1G	6	
A1	550	32	Green	Front-Back	M239096	BFB32A1G	6	
A1	550	32	White	Front-Front	G239091	BFF32A1W	6	BNEUTRALA1
A1	550	32	White	Back-Back	H239092	BBB32A1W	6	
A1	550	32	White	Front-Back	J239093	BFB32A1W	6	
A2	690	32	Black	Front-Front	C230140	BFF32A2	6	BTIA55Vxx BTIA69Vxx
A2	690	32	Black	Back-Back	P1012542	BBB32A2	6	
A2	690	32	Black	Front-Back	D230141	BFB32A2	6	
A2	690	32	Green	Front-Front	Z1012551	BFF32A2G	6	
A2	690	32	Green	Back-Back	S1012545	BBB32A2G	6	
A2	690	32	Green	Front-Back	W1012548	BFB32A2G	6	
A2	690	32	White	Front-Front	A1012552	BFF32A2W	6	BNEUTRALA2
A2	690	32	White	Back-Back	T1012546	BBB32A2W	6	
A2	690	32	White	Front-Back	X1012549	BFB32A2W	6	
A3	690	63	Black	Front-Front	F230143	BFF63A3	6	BTSS42Vxx BTS42Vxx BTS42Vxxx BTIS69Vxx
A3	690	63	Black	Back-Back	V239103	BBB63A3	6	
A3	690	63	Black	Front-Back	G230144	BFB63A3	6	
A3	690	63	Green	Front-Front	Z239107	BFF63A3G	6	
A3	690	63	Green	Back-Back	A239108	BBB63A3G	6	
A3	690	63	Green	Front-Back	B239109	BFB63A3G	6	
A3	690	63	White	Front-Front	W239104	BFF63A3W	6	BNEUTRALA3
A3	690	63	White	Back-Back	X239105	BBB63A3W	6	
A3	690	63	White	Front-Back	Y239106	BFB63A3W	6	
A4	690	125	Black	Front-Front	H230145	BFF125A4	1	BTSD42Vxxx BTCP42Vxxx BTCP69Vxxx
A4	690	125	Black	Back-Back	C239110	BBB125A4	1	
A4	690	125	Black	Front-Back	J230146	BFB125A4	1	
A4	690	125	Green	Front-Front	K239117	BFF125A4G	1	
A4	690	125	Green	Back-Back	L239118	BBB125A4G	1	
A4	690	125	Green	Front-Back	M239119	BFB125A4G	1	
A4	690	125	White	Front-Front	D239111	BFF125A4W	1	BNEUTRALA4
A4	690	125	White	Back-Back	E239112	BBB125A4W	1	
A4	690	125	White	Front-Back	F239113	BFB125A4W	1	

Additional neutral links

REFERENCE NUMBER	CATALOGUE NUMBER	MERSEN FUSE/NEUTRAL LINK TYPE
Q1065581	BNEUTRALB2	BSGP NEUTRAL LINK B2 200A
R1065582	BNEUTRALB4	BSGP NEUTRAL LINK B4 400A
T1065584	BNEUTRALC3	BSGP NEUTRAL LINK C3 800A
S1065583	BNEUTRALC1	BSGP NEUTRAL LINK C1 400A

BS88 FUSE HOLDERS & NEUTRAL LINK

Technical characteristics

SPECIFICATIONS	F1	F2	A1	A2	A3	A4
3 kinds of electrical connections in Black White & Green						
Front connected	BFF32F1	BFF63F2	BFF32A1	BFF32A2	BFF63A3	BFF125A4
Back connected	BBB32F1	BBB63F2	BBB32A1	BBB32A2	BBB63A3	BBB125A4
Front Back connected	BFB32F1	BFB63F2	BFB32A1	BFB32A2	BFB63A3	BFB125A4
Cable cross-section for font connection						
Min: 1 or 2 cables	1 mm ²	1 mm ²	1 mm ²	1 mm ²	1 mm ²	1 mm ²
Max: 1 cable	16 mm ²	25 mm ²	16 mm ²	16 mm ²	50 mm ²	70 mm ²
Max: 2 cables	10 mm ²	16 mm ²	10 mm ²	10 mm ²	25 mm ²	35 mm ²
Type of wire to be used: Copper multi strand or single strand Note: Multistrand cable with maximum 17 strands. For more than 17 strands a circular sleeve at the end of the cable is compulsory						
Lug diameter of the cable for Back & Busbar connection terminal diameter (refer Note)	M6	M8	M6	M6	M8	M8
DIN Rail Mounting	35 mm DIN Rail					
Whether the plastic material complies with RoHS	Thermoplastic Polyamid, RoHS compliant & Fire Retardant					
Diameter of the screw to be used for panel mounting Deep base = 4mm	M5 screw (Pan head/Cheese head)					
Max torque for the mounting screw on the panel	3.5 Nm	4 Nm	3.5 Nm	4 Nm	3.5 Nm	4 Nm
Max torque for the grub screw (back & bus bar connections)	3.5 Nm	4 Nm	3.5 Nm	3.5 Nm	3.5 Nm	4 Nm
Certification	ASTA					
Rated Voltage	550 V AC 250 V DC	550 V AC	550 V AC 250 V DC	690 V AC 460 V DC	690 V AC 460 V DC	690 V AC 460 V DC
Rated Current	32 A	63 A	32 A	32 A	63 A	125 A
Rated peak withstand current @ rated voltage	80 kA					
Tool specification for tightening Electric Screw driver / Manual crew driver - Max Torque setting	3.5 Nm	4 Nm	3.5 Nm	4 Nm	4 Nm	4 Nm
Screwdriver bit	Diameter 6 x 100mm					
with working edge thickness of 1mm and width of 7mm	0.8 x 4.8 mm	1 x 6 mm	0.8 x 4.8 mm	1 x 6 mm	1 x 6 mm	1 x 6 mm
U imp according to IEC 60269-1	8 kA					

BS88 FUSE HOLDERS & NEUTRAL LINK

Dimensions for F type

Front Front Connection (BFF)

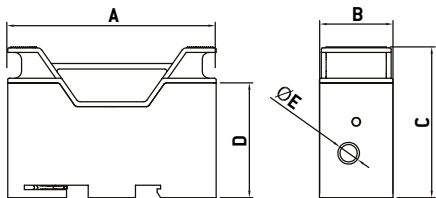

Back Back Connection (BBB)

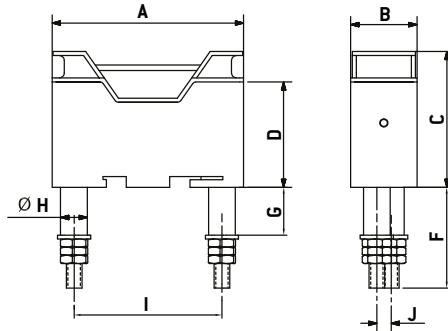

Front Back (Busbar) Connection (BFB)

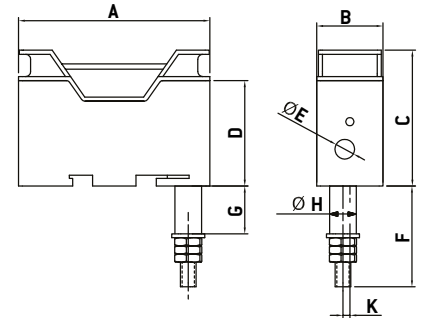

FUSE HOLDER TYPE	A	B	C	D	E	F	G	H	I	J	K
BFF32F1	75.5	26.5	54	41.5	7.8	-	-	-	-	-	-
BBB32F1	75.5	26.5	54	41.5	-	40	17	9.7	58	5.6	-
BFB32F1	75.5	26.5	54	41.5	7.8	40	17	9.7	-	-	2.7
BFF63F2	89	28.5	64	48.6	9	-	-	-	-	-	-
BBB63F2	89	28.5	64	48.6	-	39	18.3	12	67	7	-
BFB63F2	89	28.5	64	48.6	9	39	18.3	12	-	-	3.3

Panel Drilling Dimensions

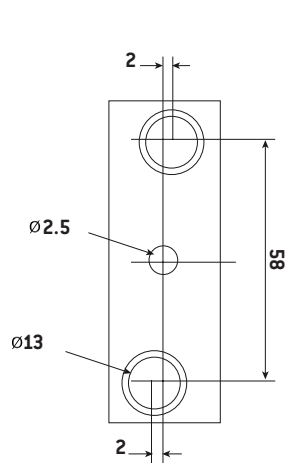

For F1

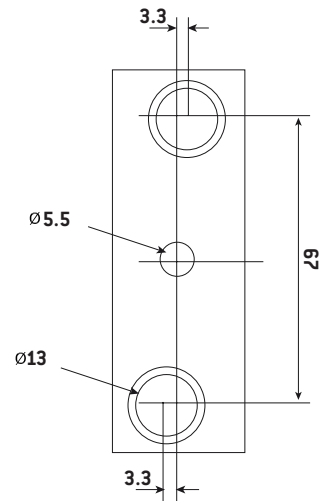

For F2

BS88 FUSE HOLDERS & NEUTRAL LINK

Dimensions for A type

Front Front Connection (BFF)

Back Back Connection (BBB)

Front Back (Busbar) Connection (BFB)

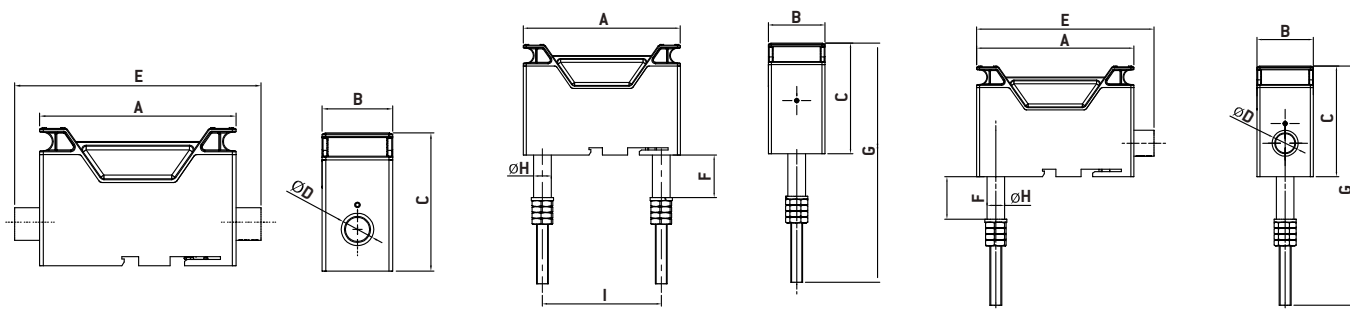

FUSE HOLDER TYPE	A	B	C	D	E	F	G	H	I
BFF32A1	77.2	27.5	57	9	97.2	-	-	-	-
BBB32A1	77.2	27.5	57	-	-	28.6	122	11.9	58
BFB32A1	77.2	27.5	57	9	87.2	28.6	122	11.9	-
BFF32A2	99.8	33	56	9	119.8	-	-	-	-
BBB32A2	99.8	33	56	-	-	28.6	122	11.9	76.1
BFB32A2	99.8	33	56	9	109.8	28.6	122	11.9	-
BFF63A3	105.8	38	74.5	17.5	132.8	-	-	-	-
BBB63A3	105.8	38	74.5	-	-	28.6	161	11.9	80
BFB63A3	105.8	38	74.5	17.5	119.3	28.6	161	11.9	-
BFF125A4	134	48.9	97.8	17.5	165.7	-	-	-	-
BBB125A4	134	48.9	97.8	-	-	28.6	184.4	11.9	94.1
BFB125A4	134	48.9	97.8	17.5	149.9	28.6	184.4	11.9	-

Panel Drilling Dimensions

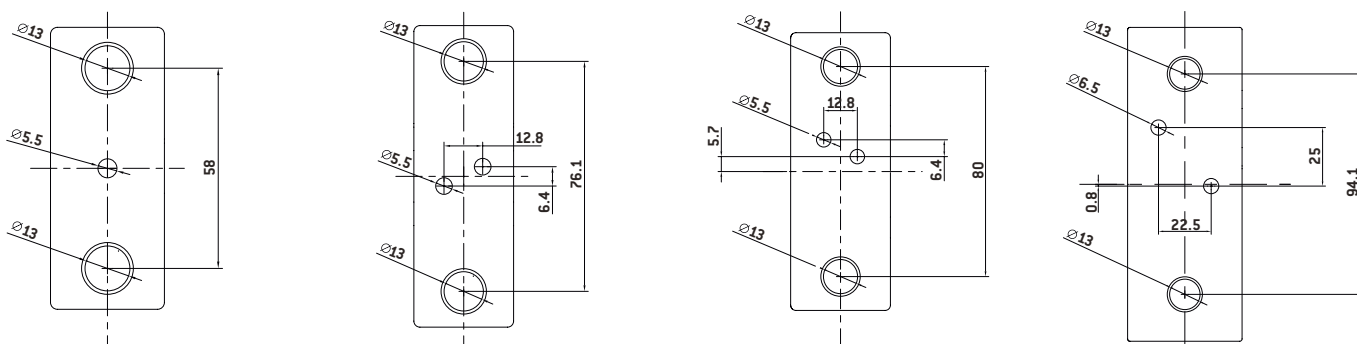

For A1

For A2

For A3

For A4

BS88 FUSE HOLDERS & NEUTRAL LINK

For Offset Blade - Phenolic Type

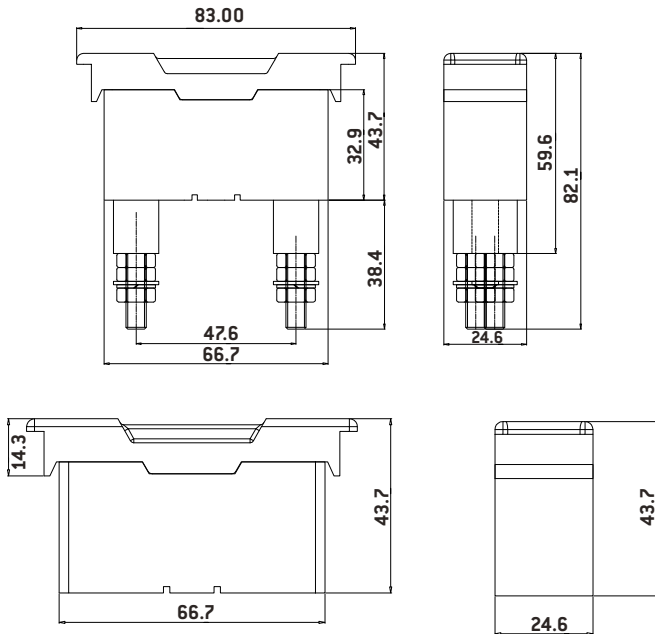

TYPE	VOLTAGE RATING (V)	NOMINAL CURRENT (A)	COLOR	CONNECTION	REFERENCE NUMBER	CATALOGUE NUMBER	STANDARD PACK	MERSEN FUSE TYPE
INDIAN MARKET ONLY								
F1	550	32	Black	Front-Front	T1036995F	BNSH32F1	6	BNS55Vxx
F1	550	32	Black	Back-Back	W1036297F	BNSP32F1	6	

TYPE	VOLTAGE RATING (V)
Front connected	BFF32F1
Back connected	BBB32F1
Cable cross-section for font connection	
Min: 1 or 2 cables	1 mm ²
Max: 1 cable	16 mm ²
Max: 2 cables	10 mm ²
Type of wire to be used: Copper multi strand or single strand Note: Multistrand cable with maximum 17 strands. For more than 17 strands a circular sleeve at the end of the cable is compulsory	
Lug diameter of the cable for Back & Busbar connection terminal diameter (refer Note)	M6
Diameter of the screw to be used for panel mounting Deep base = 4mm	M5 screw (Pan head/Cheese head)
Max torque for the mounting screw on the panel	3.5 Nm
Max torque for the grub screw (back & bus bar connections)	3.5 Nm
Rated Voltage	550 V AC
Rated Current	32 A
Rated peak withstand current @ rated voltage	80 kA
Tool specification for tightening Electric Screw driver / Manual crew driver - Max Torque setting	3.5 Nm
Screwdriver bit	Diameter 6 x 100mm
with working edge thickness of 1mm and width of 7mm	0.8 x 4.8 mm
U imp according to IEC 60269-1	8 kV

MERSEN PROFILE & RANGE MAPPING

Range Mapping

CATALOGUE NUMBER	VOLTAGE AC	AMPS	BREAKING CAPACITY KA	STANDARDS
BLD 24 V	240 V	6,10,16,20,25	16.5	"IEC 60269 Pt 1 & 2, BS 88 Pt 1 & 2"
BLD 24 V	240 V	30	16.5	BSHD 60269-3 (BS1361)
BMD 42 V	415 V	2,4,6,8,10,20,25,32	80.0	"IEC 60269 Pt 1 & 2 BS 88 Pt 1 & 2"
BLST 24 V	240 V	2,4,6,10,16,20,25,32	33.0	"IEC 60269 Pt 1 & 2 BS 88 Pt 1 & 2"

BLD	24 V	10	BMD	42 V	10	BLST	24 V	10
FUSE FAMILY	VOLTAGE	AMP RATING	FUSE FAMILY	VOLTAGE	AMP RATING	FUSE FAMILY	VOLTAGE	AMP RATING
	240 V	10 A		415 V	10 A		240 V	10 A

Comparison Chart for BLD/BMD/BLST Fuse Links

COMPETITORS		MERSEN	RATINGS
LD 6-25,240 V	C 3030-240 V	BLD24 V...	6,10,16,20,25
LD 30	C 3030-240 V	BLD24 V...	30
LST 2-32,240 V	STD 2-32,240 V	BLST24 V...	2,4,6,10,16,20,25,32
MD 2-32,415 V	SMD 2-32,415 V	BMD42 V...	2,4,6,8,10,16,20,25,32

CYLINDRICAL
FUSES FOR STREET
LIGHTING PROTECTION

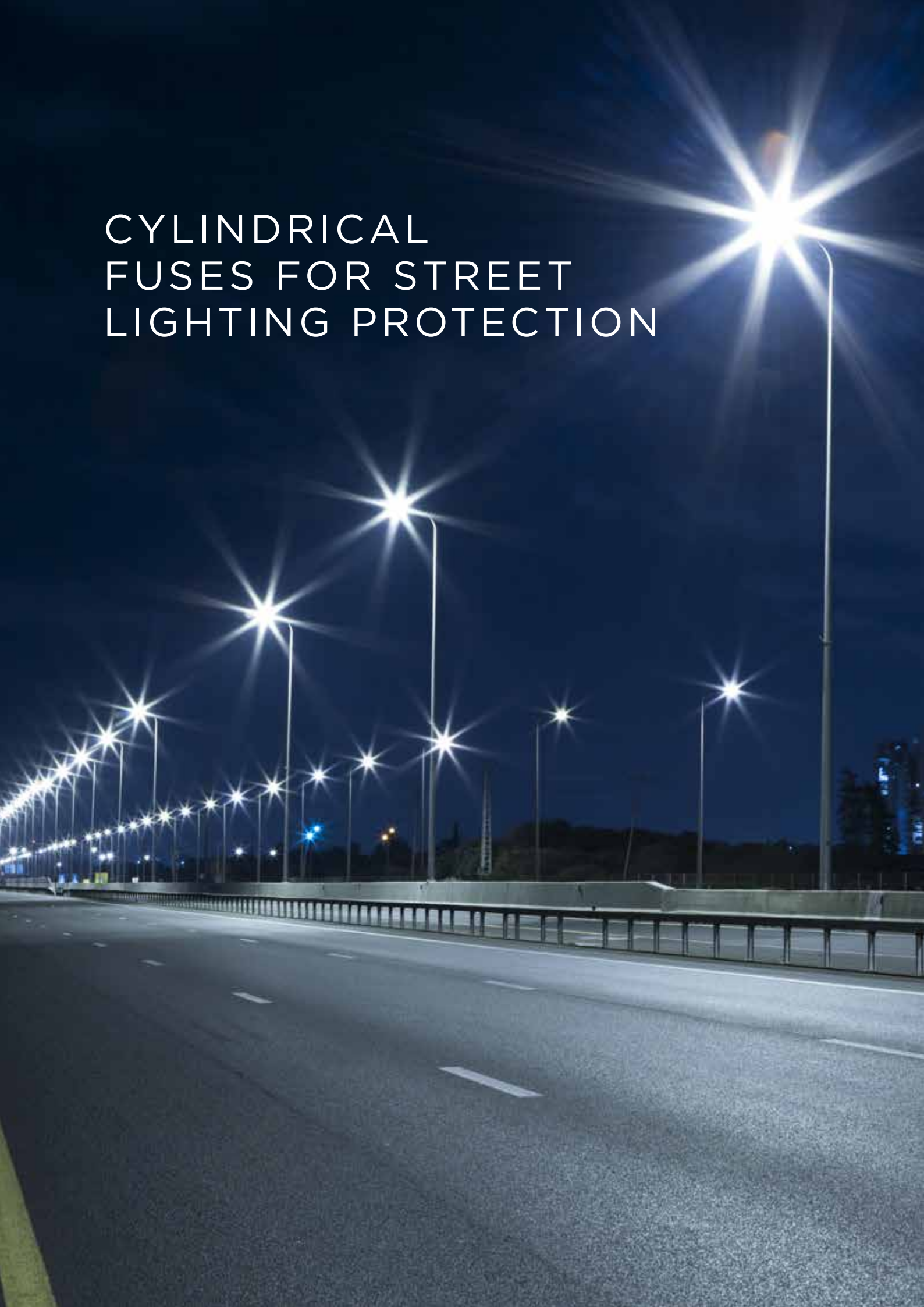

BLD/BMD/BLST FUSE LINKS

Simplicity and high reliability

The majority of existing street lighting networks are normally protected by a common Feeder Protection Device (FPD). FPD is based on a simple overcurrent unidirectional technique to protect against faults on the street lighting cables. The Mersen fuse technology ensures safety in street lighting applications by providing better coordination, immediate isolation and ensures fire safety through safe and correct fuse selection.

All the circuit protection solutions shown in this catalogue are ASTA 20 certified* and comply with the RoHS European Directive. Mersen BS88 fuses are UKCA and CE approved.

For your own safety do NOT open BS88 fuse holders on load.

* Note that any items marked with * are not ASTA 20 certified.



Cylindrical Type BLD Fuse Links	38
BLD time current / cut-off curve	39
BS Cylindrical Type BMD Fuse Links	40
BMD time current / cut-off curve	41
Offset Bolted Tag BLST Fuse Links	42
BLST time current / cut-off curve	43

CYLINDRICAL TYPE BLD FUSE LINKS

Reference data: BLD

Rated Voltage: 240 V ac Breaking Capacity: 16.5 kA

Full Range Protection, gG



PART REFERENCE	PART DESCRIPTIONS	VOLTAGE (VOLTS)	RATINGS (AMPS)		STANDARD PACKING
			IEC 60269-PT 1&2	BSHD 602693 (BS 1361)	
M1065693	BLD24 V6	240V	6	--	10
N1065694	BLD24 V10		10	--	10
P1065695	BLD24 V16		16	--	10
Q1065696	BLD24 V20		20	--	10
R1065697	BLD24 V25		25	--	10
T1065699	BLD24 V30		--	30	10

Dimensions

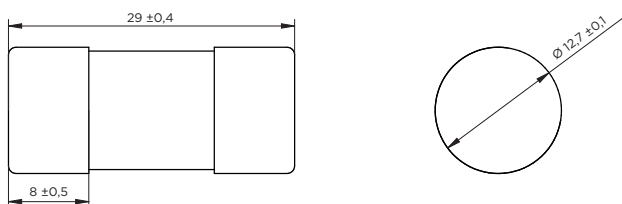

Cylindrical Type BLD Fuse Links

FUSE TYPE	CURRENT RATINGS AMPS	DIMENSIONS IN MM		
		A MAX	B MAX	C MAX
BLD	6,10,16,20,25,32	29.4	12.8	8.5

Electrical Characteristics

FUSE TYPE	VOLTAGE AC	CURRENT RATINGS AMPS	PRE - ARCING I ² T (AMPERE ² SECONDS)	CLEARING I ² T (AMPERE ² SECONDS)	WATT LOSS
BLD	240 V	6	13	20	1.98
		10	25	63	1.53
		16	204	510	1.54
		20	459	1148	1.54
		25	625	1563	2.14
		30	816	2041	2.85

BLD TIME CURRENT / CUT-OFF CURVE

BLD time current curves

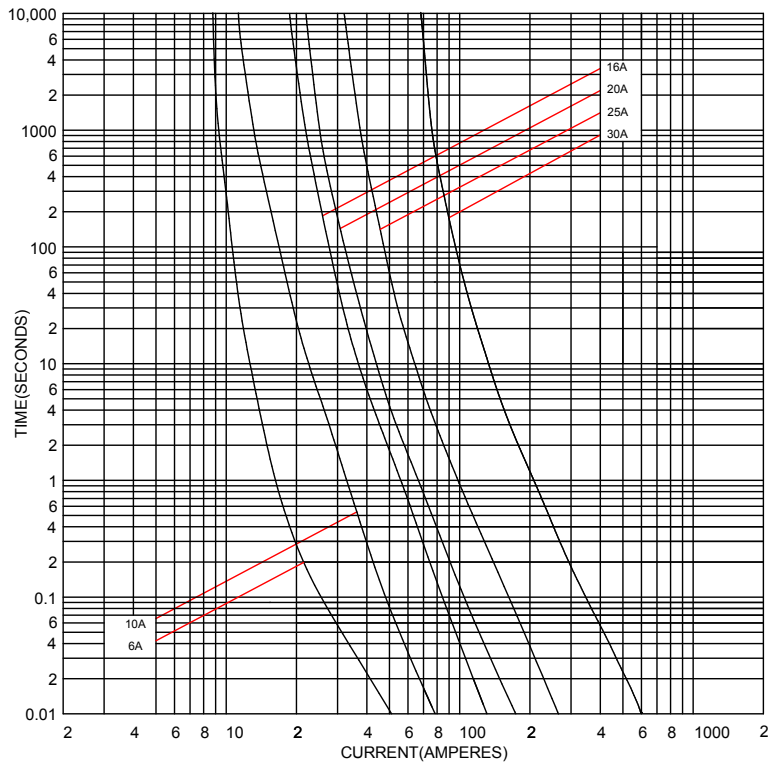

BLD cut-off curve

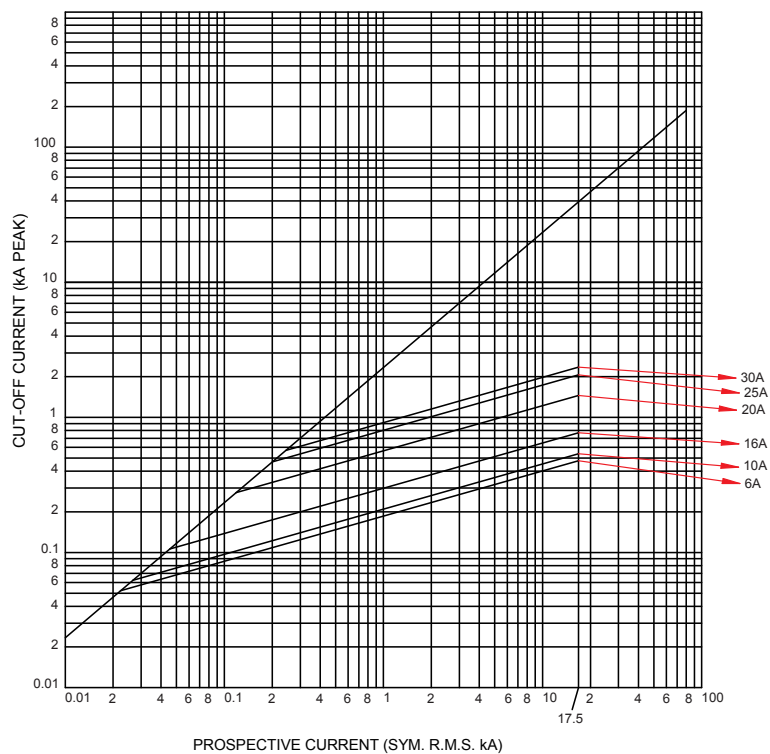

BS CYLINDRICAL TYPE BMD FUSE LINKS

Reference data: BMD

Rated Voltage: 415 V AC, Breaking Capacity: 80 kA

Full Range Protection, gG



PART REFERENCE	PART DESCRIPTIONS	VOLTAGE (VOLTS)	RATINGS (AMPS)	STANDARD PACKING
V1036973	BMD42 V2	415 V	2	10
W1036974	BMD42 V4		4	10
X1036975	BMD42 V6		6	10
P1065074	BMD42 V8		8	10
Y1036976	BMD42 V10		10	10
Z1036977	BMD42 V16		16	10
A1036978	BMD42 V20		20	10
B1036979	BMD42 V25		25	10
C1036980	BMD42 V32		32	10

Dimensions

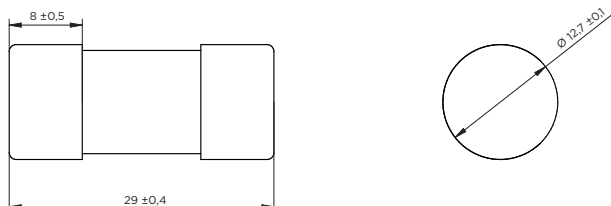

Cylindrical Type BLD Fuse Links

FUSE TYPE	CURRENT RATINGS AMPS	DIMENSIONS IN MM		
		A MAX	B MAX	C MAX
BMD	2,4,6,8,10,16,20,25,30,32	29.4	12.8	8.5

Electrical Characteristics

FUSE TYPE	VOLTAGE AC	CURRENT RATINGS AMPS	PRE - ARCING I ² T (AMPERE ² SECONDS)	CLEARING I ² T (AMPERE ² SECONDS)	WATT LOSS
BMD	415 V	2	1	3.5	1.17
		4	8	27	1.48
		6	22	77	1.54
		8	13	55	1.01
		10	27	113	1.42
		16	107	451	1.43
		20	241	1015	1.52
		25	428	1805	2.28
		32	668	2821	2.64

BMD TIME CURRENT / CUT-OFF CURVE

BMD time current curves

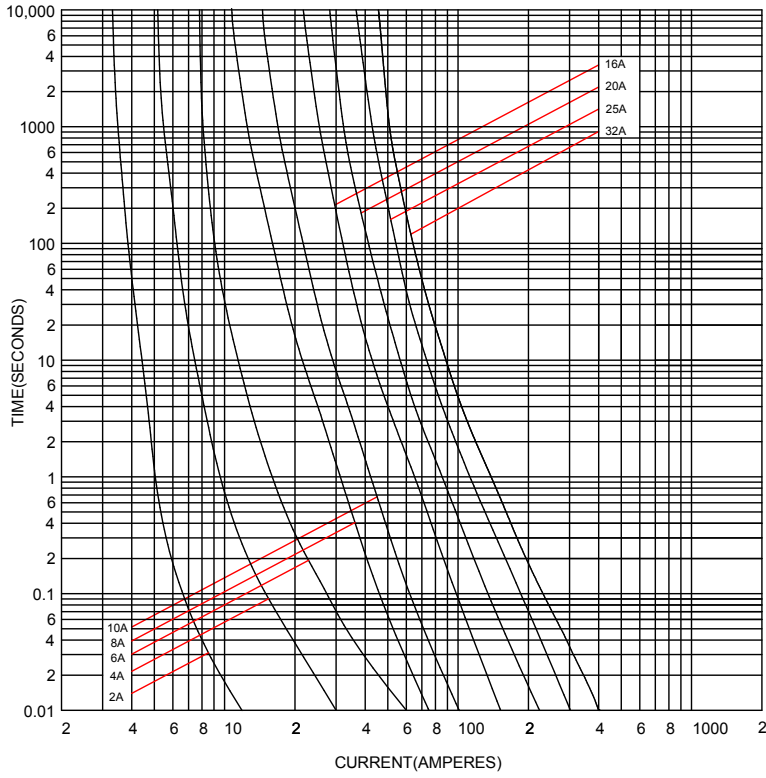

BMD cut-off curve

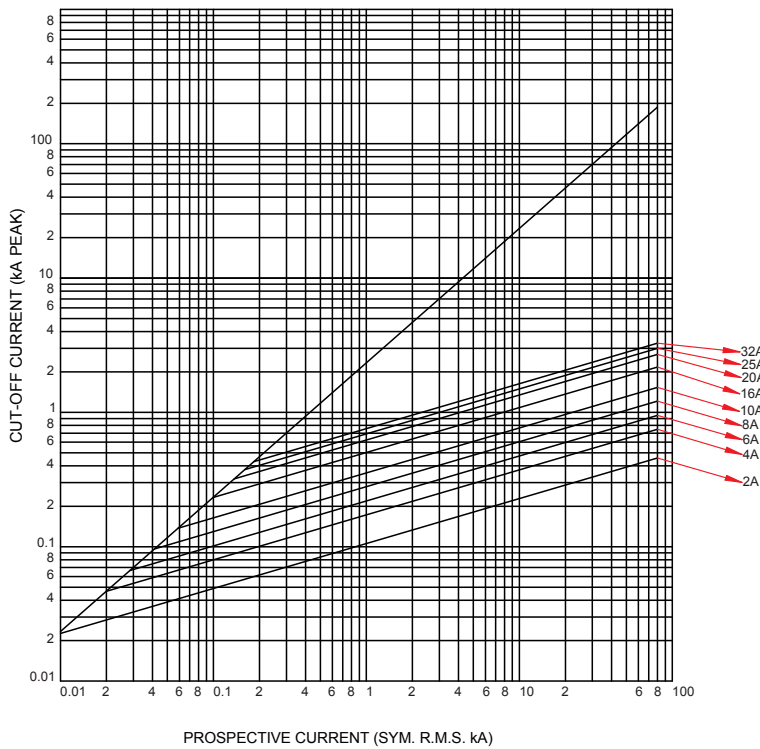

OFFSET BOLTED TAG BLST FUSE LINKS

Reference data: BLST

Rated Voltage: 240V AC Breaking Capacity: 33 kA

Full Range Protection - gG



PART REFERENCE	PART DESCRIPTIONS	VOLTAGE (VOLTS)	RATINGS (AMPS)	STANDARD PACKING
D1065685	BLST24 V2	240 V	2	10
E1065686	BLST24 V4		4	10
F1065687	BLST24 V6		6	10
G1065688	BLST24 V10		10	10
H1065689	BLST24 V16		16	10
J1065690	BLST24 V20		20	10
K1065691	BLST24 V25		25	10
L1065692	BLST24 V32		32	10

Dimensions

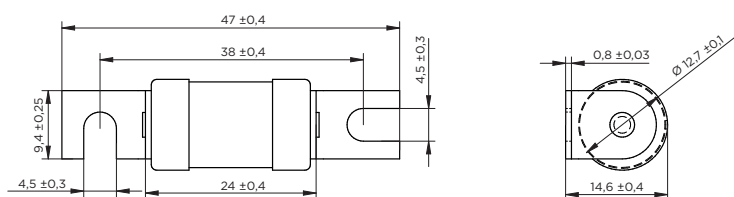

Cylindrical Type BLD Fuse Links

FUSE TYPE	CURRENT RATINGS AMPS	DIMENSIONS IN MM						
		A MAX	B MAX	D MAX	E MAX	F MAX	G MAX	H MAX
BLST	2,4,6,10, 16,20,25,32	24.4	12.8	47.4	9.65	0.83	38.4	15

Electrical Characteristics

FUSE TYPE	VOLTAGE AC	CURRENT RATINGS AMPS	PRE - ARCING I ² T (AMPERE ² SECONDS)	CLEARING I ² T (AMPERE ² SECONDS)	WATT LOSS
BLST	240 V	2	0.6	1	1.02
		4	5	7	1.29
		6	10	16	1.33
		10	29	67	1.40
		16	152	348	1.79
		20	533	1225	1.04
		25	725	1668	1.80
		32	947	2178	2.64
32	668	2821	2.64		

BLST TIME CURRENT / CUT-OFF CURVE

BLST time current curves

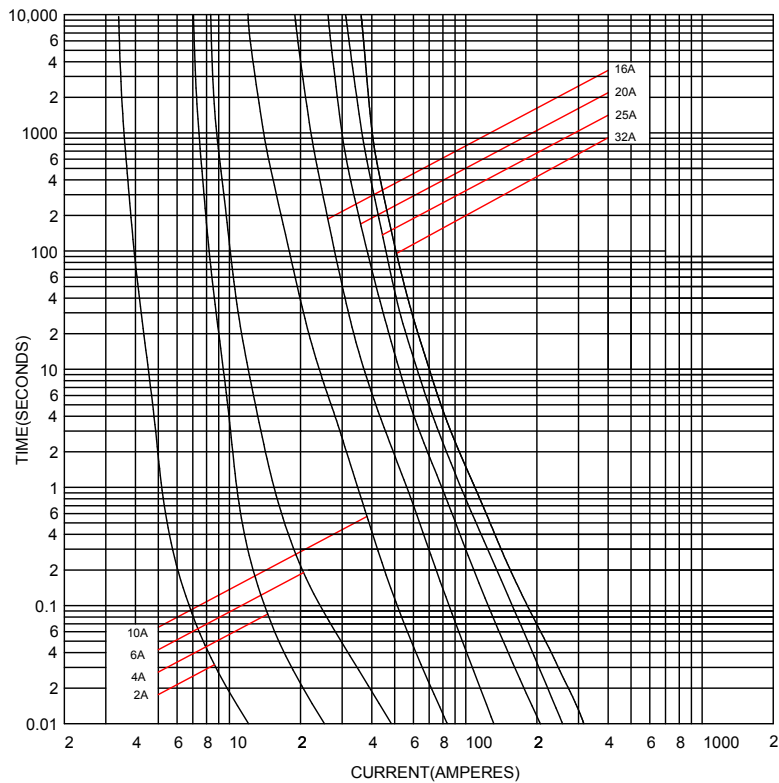

BLST cut-off curve

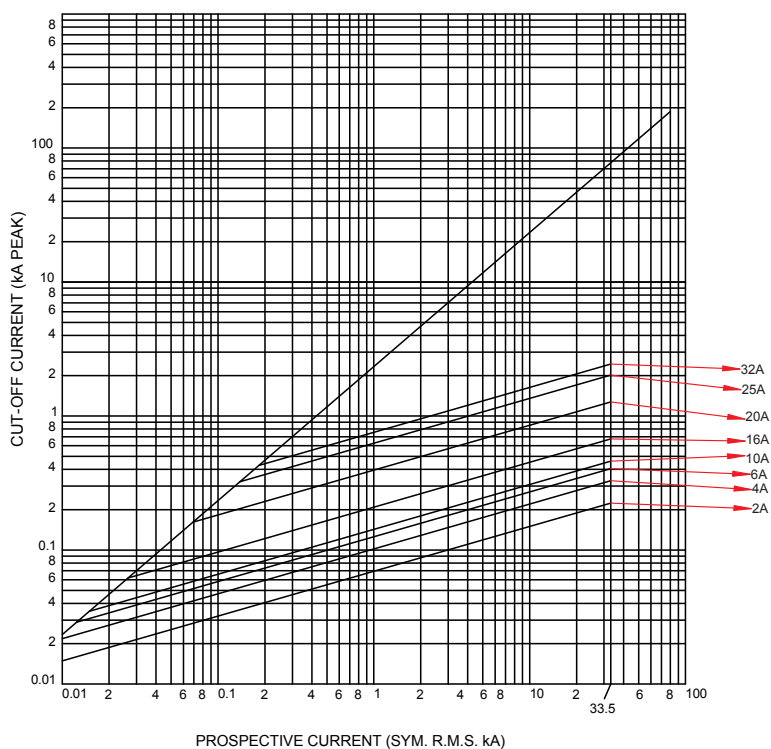



LOW VOLTAGE
DISTRIBUTION WIRING
SYSTEMS

FEEDER PILLAR FUSE LINKS

Ensuring continuous service

The Mersen range of Low Voltage Feeder Pillar Fuse Links are designed for the use with wedge type fuse carriers with fixing centres of 82mm and 92mm. These are primarily for use by Electricity Supply Industries in distribution pillars, open type substation boards, heavy duty service cut-outs and underground disconnecting boxes.

The Mersen range of House Service Fuse Links are designed for the use in consumer distribution boards, electricity control units, houses and office buildings.

All the circuit protection solutions shown in this catalogue are ASTA 20 certified* and comply with the RoHS European Directive. Mersen BS88 fuses are UKCA and CE approved.

For your own safety do NOT open BS88 fuse holders on load.

* Note that any items marked with * are not ASTA 20 certified.



Feeder Pillar Fuse Links 415VAC 80kA	46
Feeder Pillar Fuse Links 415VAC 80kA time current / cut-off curve	48
Feeder Pillar Fuse Links 415VAC 33kA	49
Feeder Pillar Fuse Links 415VAC 33kA time current / cut-off curve	51
Comparison chart	55
Application information	53
Approvals	55

FEEDER PILLAR FUSE LINKS 415VAC 80KA

Reference data

Rated Voltage: 415V AC

Breaking Capacity: 80kA

ASTA 20 Certified



VOLTAGE (V)	RATING (A)	CATALOG NUMBER	FS STANDARD REFERENCE	BS STANDARD REFERENCE	IEC STANDARD REFERENCE	FIXING CENTRE (MM)	PACK.
415	20	BJU42V020PA	H1003888F	BS88-5	IEC60269-2	82	6
	25	BJU42V025PA	J1003889F	BS88-5	IEC60269-2	82	6
	32	BJU42V032PA	K1003890F	BS88-5	IEC60269-2	82	6
	40	BJU42V040PA	L1003891F	BS88-5	IEC60269-2	82	6
	50	BJU42V050PA	M1003892F	BS88-5	IEC60269-2	82	6
	63	BJU42V063PA	N1003893F	BS88-5	IEC60269-2	82	6
	80	BJU42V080PA	P1003894F	BS88-5	IEC60269-2	82	6
	100	BJU42V100PA	Q1003895F	BS88-5	IEC60269-2	82	6
	125	BJU42V125PA	R1003896F	BS88-5	IEC60269-2	82	6
	160	BJU42V160PA	S1003897F	BS88-5	IEC60269-2	82	6
	200	BJU42V200PA	T1003898F	BS88-5	IEC60269-2	82	6
415	20	BJU42V020SA	V1003899C	BS88-5	IEC60269-2	92	3
	25	BJU42V025SA	W1003900C	BS88-5	IEC60269-2	92	3
	32	BJU42V032SA	X1003901C	BS88-5	IEC60269-2	92	3
	40	BJU42V040SA	Y1003902C	BS88-5	IEC60269-2	92	3
	50	BJU42V050SA	Z1003903C	BS88-5	IEC60269-2	92	3
	63	BJU42V063SA	A1003904C	BS88-5	IEC60269-2	92	3
	80	BJU42V080SA	B1003905C	BS88-5	IEC60269-2	92	3
	100	BJU42V100SA	C1003906C	BS88-5	IEC60269-2	92	3
	125	BJU42V125SA	D1003907C	BS88-5	IEC60269-2	92	3
	160	BJU42V160SA	H1003911C	BS88-5	IEC60269-2	92	3
	200	BJU42V200SA	V1003922C	BS88-5	IEC60269-2	92	3
415	250	BJU42V250PB	W1003923C	BS88-5	IEC60269-2	82	3
	315	BJU42V315PB	Y1003925C	BS88-5	IEC60269-2	82	3
	355	BJU42V355PB	Z1003926C	BS88-5	IEC60269-2	82	3
	400	BJU42V400PB	D1003930C	BS88-5	IEC60269-2	82	3
415	250	BJU42V250SB	E1003931C	BS88-5	IEC60269-2	92	3
	315	BJU42V315SB	F1003932C	BS88-5	IEC60269-2	92	3
	355	BJU42V355SB	G1003933C	BS88-5	IEC60269-2	92	3
	400	BJU42V400SB	H1003934C	BS88-5	IEC60269-2	92	3
415	450	BJU42V450SC	J1003935A	BS88-5	IEC60269-2	92	1
	500	BJU42V500SC	F1003955A	BS88-5	IEC60269-2	92	1
415	560	BJU42V560SD	G1003956A	BS88-5	IEC60269-2	92	1
	630	BJU42V630SD	H1003957A	BS88-5	IEC60269-2	92	1

FEEDER PILLAR FUSE LINKS 415VAC 80KA

Dimensions

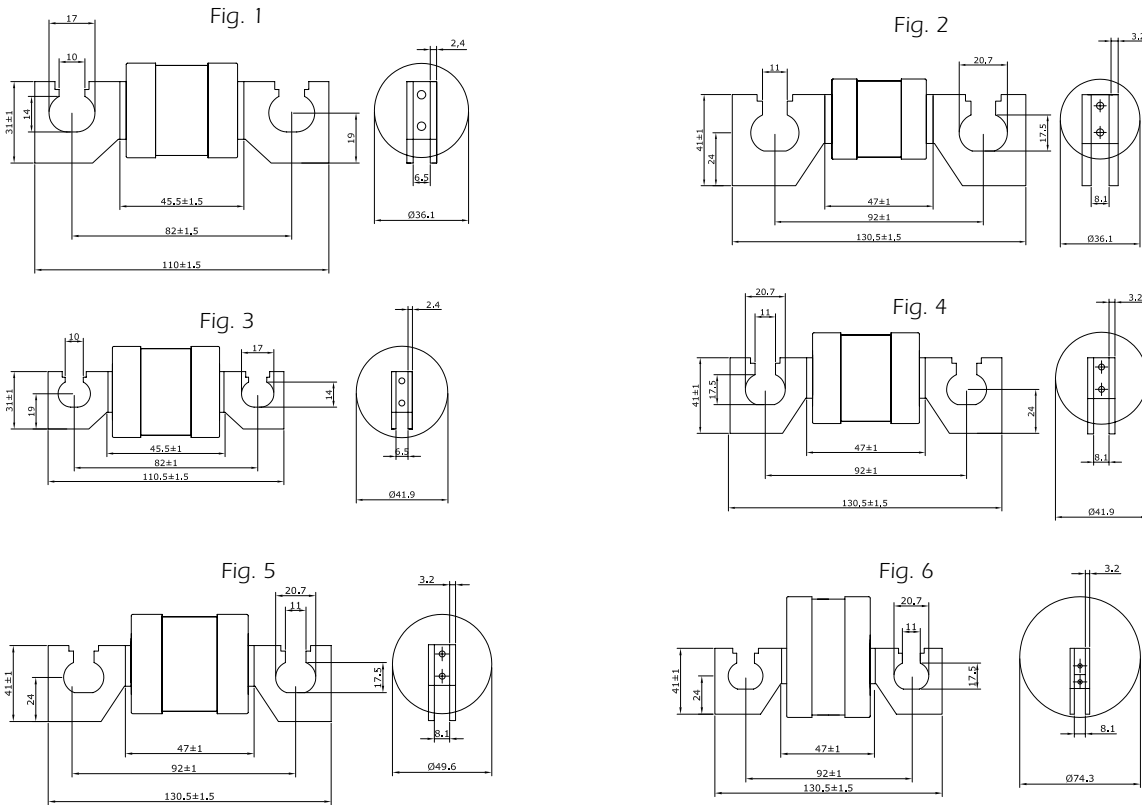

Electrical characteristics

FUSE TYPE	RATING (A)	CURVE	I ² T (AMPERE ² SECONDS)		WATTS LOSS
			PRE ARCING	TOTAL	
BJU42V020PA/SA	20	gU	100	1125	2.4
BJU42V025PA/SA	25	gU	250	1890	2.7
BJU42V032PA/SA	32	gU	670	3000	3.2
BJU42V040PA/SA	40	gU	1300	5850	4.5
BJU42V050PA/SA	50	gU	2600	11700	4.8
BJU42V063PA/SA	63	gU	4000	18000	6.2
BJU42V080PA/SA	80	gU	4150	21000	8.4
BJU42V100PA/SA	100	gU	8240	37000	8.7
BJU42V125PA/SA	125	gU	16600	74700	9.3
BJU42V160PA/SA	160	gU	37500	168000	10.7
BJU42V200PA/SA	200	gU	57000	256500	16.2
BJU42V250PB/SB	250	gU	60000	270000	20
BJU42V315PB/SB	315	gU	105000	472500	27
BJU42V355PB/SB	355	gU	134000	603300	29
BJU42V400PB/SB	400	gU	160000	720000	32
BJU42V450SC	450	gU	210000	945000	36
BJU42V500SC	500	gU	302000	1359000	37
BJU42V560SD	560	gU	485000	2910000	35
BJU42V630SD	630	gU	634000	3800000	39

FIG. NO.	CATALOG REFERENCE
1	BJU42V020PA - BJU42V200PA
2	BJU42V020SA - BJU42V200SA
3	BJU42V250PB - BJU42V400PB
4	BJU42V250SB - BJU42V400SB
5	BJU42V450SC - BJU42V500SC
6	BJU42V560SD - BJU42V630SD

FEEDER PILLAR FUSE LINKS 415VAC 80KA TIME CURRENT / CUT-OFF CURVE

Time vs. current characteristics

gU curves - 20 TO 630A - 415VAC

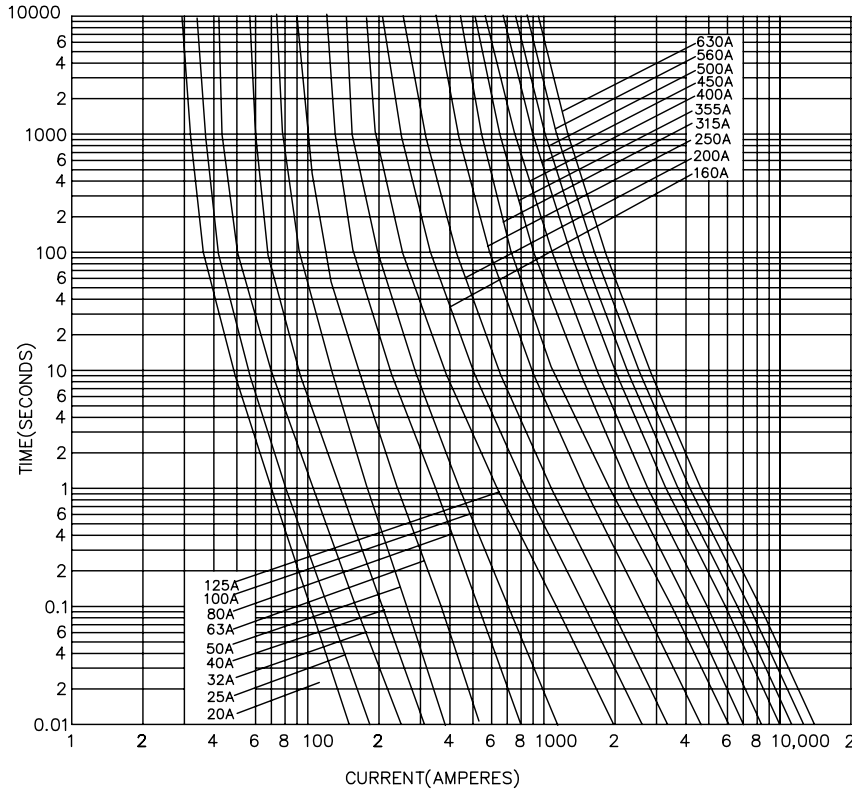

Cut off - current characteristics

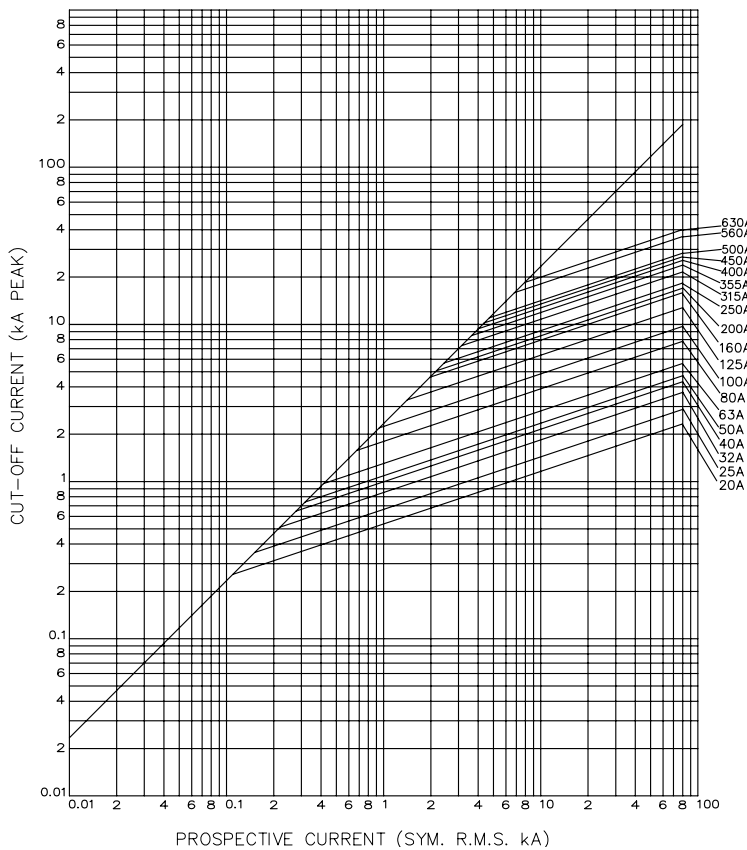

FEEDER PILLAR FUSE LINKS 415VAC 33KA

Reference data

Rated Voltage: 415V ac
Breaking Capacity: 33kA
ASTA 20 Certified



VOLTAGE (V)	RATING (A)	CATALOG NUMBER	FS STANDARD REFERENCE	BS STANDARD REFERENCE	IEC STANDARD REFERENCE	FIXING CENTRE (MM)	PACK.
415	5	BME42V05	C1003860J	BS1361	IEC60269-3	22x57	10
	10	BME42V10	D1003861J	BS1361	IEC60269-3	22x57	10
	15	BME42V15	E1003862J	BS1361	IEC60269-3	22x57	10
	20	BME42V20	F1003863J	BS1361	IEC60269-3	22x57	10
	25	BME42V25	G1003864J	BS1361	IEC60269-3	22x57	10
	30	BME42V30	H1003865J	BS1361	IEC60269-3	22x57	10
	40	BME42V40	L1003868J	BS1361	IEC60269-3	22x57	10
	45	BME42V45	N1003870J	BS1361	IEC60269-3	22x57	10
	50	BME42V50	Q1003872J	BS1361	IEC60269-3	22x57	10
	60	BME42V60	R1003873J	BS1361	IEC60269-3	22x57	10
	70	BME42V70	S1003874J	BS1361	IEC60269-3	22x57	10
	80	BME42V80	T1003875J	BS1361	IEC60269-3	22x57	10
415	30	BMF42V30	V1003876F	BS1361	IEC60269-3	30x57	6
	40	BMF42V40	W1003877F	BS1361	IEC60269-3	30x57	6
	50	BMF42V50	X1003878F	BS1361	IEC60269-3	30x57	6
	60	BMF42V60	Y1003879F	BS1361	IEC60269-3	30x57	6
	70	BMF42V70	Z1003880F	BS1361	IEC60269-3	30x57	6
	80	BMF42V80	A1003881F	BS1361	IEC60269-3	30x57	6
	100	BMF42V100	B1003882F	BS1361	IEC60269-3	30x57	6

Dimensions

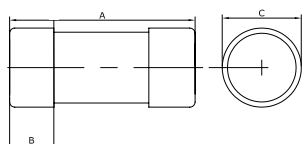

SIZE (MM)	FUSE TYPE	CURRENT RATING (A)	DIMENSIONS (MM)		
			A	B	C
22x57	BME	5,10,15,20,25,30,40,45,50,60,70,80	57	16	22.23
30x57	BMF	30,40,50,60,70,80,100	57	16	30.16

FEEDER PILLAR FUSE LINKS

Electrical characteristics

FUSE TYPE	RATING (A)	SIZE (MM)	I ² T (AMPERE ² SECONDS)		WATTS LOSS
			PRE ARCING	TOTAL	
BME42V05	5	22x57	12	100	1.5
BME42V10	10	22x57	25	185	1.7
BME42V15	15	22x57	120	540	1.9
BME42V20	20	22x57	250	1125	2.1
BME42V25	25	22x57	300	1890	2.3
BME42V30	30	22x57	400	4500	2.65
BME42V40	40	22x57	520	5850	4.4
BME42V45	45	22x57	1250	11700	4.6
BME42V50	50	22x57	1600	16000	4.75
BME42V60	60	22x57	2100	19200	4.8
BME42V70	70	22x57	2600	26250	5.3
BME42V80	80	22x57	4000	30000	5.6
BMF42V30	30	30x57	400	4500	2.6
BMF42V40	40	30x57	520	5850	4.3
BMF42V50	50	30x57	1600	16000	4.6
BMF42V60	60	30x57	2100	19200	4.7
BMF42V70	70	30x57	2600	26250	5.2
BMF42V80	80	30x57	4000	30000	5.5
BMF42V100	100	30x57	8500	68000	5.8

FEEDER PILLAR FUSE LINKS 415VAC 33KA TIME CURRENT / CUT-OFF CURVE

Time vs. current characteristics

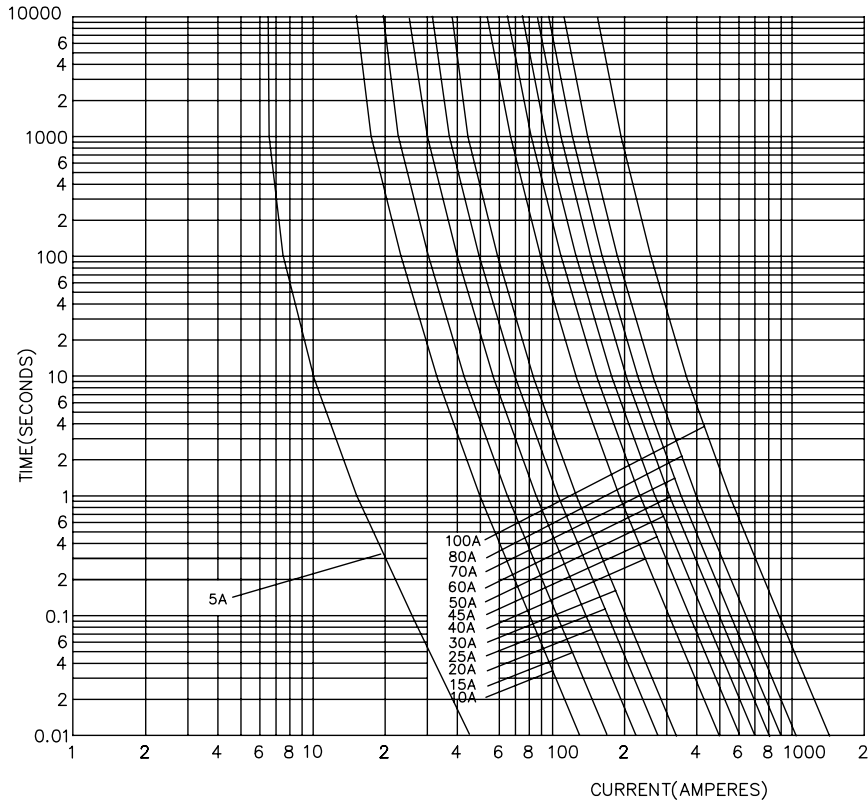

Cut off - current characteristics

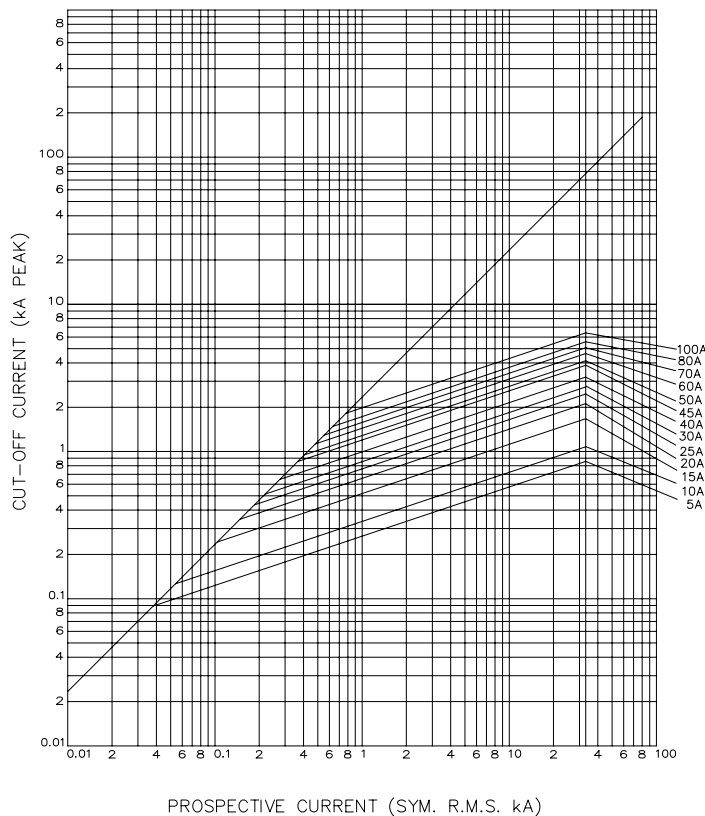

COMPARISON CHART

Comparison chart for feeder pillar fuse links

COMPETITORS		MERSEN	RATINGS
JPUxx	xxxMJ30-8	BJU42VxxxPA	20 - 200 amps
JPUxx	xxxMJ30-7	BJU42VxxxPA	20 - 200 amps
JSUxx	xxxMJ31-7	BJU42VxxxSA	20 - 200 amps
JPUxx	xxxPJ30-7	BJU42VxxxPB	250 - 400 amps
JSUxx	xxxPJ31-7	BJU42VxxxSB	250 - 400 amps
JPUxx	xxxRJ31-7	BJU42VxxxSC	450 - 500 amps
JSUxx	xxxSJ31-6	BJU42VxxxSD	560 - 630 amps

Mersen numbering system

B	JU	42V	XXX	PA
BS88	J type utility fuse	Rated Voltage [415V AC]	Current Rating	P-82mm fixing centre, A-036.1mm

Comparison chart for house service cut out fuse links

COMPETITORS		MERSEN	RATINGS
MExx	xxKR85	BME42Vxxx	5 - 80 amps
MFxx	xxxLR85	BMF42Vxxx	30 - 100 amps

Mersen numbering system

B	ME	42V	XXX
BS88	Part Number	Rated Voltage [415V AC]	Current Rating

B	MF	42V	XXX
BS88	Part Number	Rated Voltage [415V AC]	Current Rating

This list is intended for guidance only. Mersen do not guarantee identical performance for the comparative types. It is essential that the performance characteristics are checked to ensure compatibility

APPLICATION INFORMATION

Selection Procedure for Feeder Pillar Fuse Links for protection of distribution transformer

Mersen range of feeder pillar fuse-links have wedge tightening contacts of standard dimensions (82mm & 92mm) and performance intended for use in a.c. electricity supply networks. These fuses comply as per IEC60269-2, BS: 88 Part 5 requirements.

Selection:

1. The primary fuse side is selected as per table below based on transformer ratings.

RATED VOLTAGE RANGE OF FUSE-LINK (KV)		3/7.2		6/12		10/24		20/36	
SERVICE VOLTAGE OF TRANSFORMER (KV)		6		10		20		30	
REL. SHORT CIRCUIT VOLTAGE	TRANSFORMER OUTPUT (KVA)	TRANSFORMER RATED CURRENT (A)	RATED CURRENT OF FUSE-LINK (A)	TRANSFORMER RATED CURRENT (A)	RATED CURRENT OF FUSE-LINK (A)	TRANSFORMER RATED CURRENT (A)	RATED CURRENT OF FUSE-LINK (A)	TRANSFORMER RATED CURRENT (A)	RATED CURRENT OF FUSE-LINK (A)
Uk = 4%		4.8	16-20	2.9	10	1.5	4	0.96	2-6.3
	100	9.6	20-31.5	5.8	16-20	2.9	10	1.9	6.3-10
	125	12	25-40	7.2	20-25	3.6	10-16	2.4	6.3-10
	160	15.4	31.5-50	9.2	20-31.5	4.6	16-20	3.1	10
	200	19.2	40-63	11.5	25-40	5.8	16-20	3.8	10-16
	250	24.1	40-80	14.4	31.5-50	7.2	20-25	4.8	16-20
	315	30.3	50-100	18.2	40-63	9.1	20-31.5	6.3	16-25
	400	38.5	63-125	23.1	40-80	11.5	25-40	7.7	20-25
	500	8.1	80-160	28.9	50-100	14.4	31.5-50	9.6	20-31.5
Uk = 5%	800	77.1	125-200	46.2	80-125	23.1	40-63	15.4	31.5-40
	1000	96.3	125-160	57.7	100-160	28.9	50-80	19.2	40-50
	1250	120.3	160-200	72.2	125-200	36.1	63-100	24.1	40-50
Uk = 6%	1600	154	200	92.4	125-200	46.2	80-100	30.8	50-63

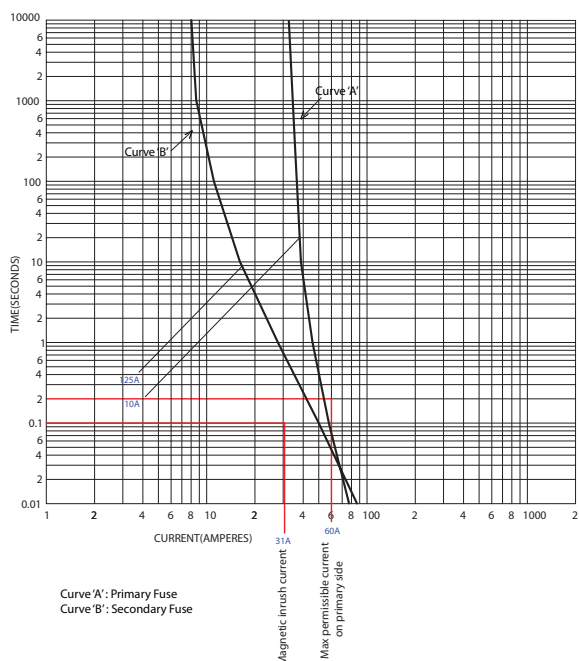

APPLICATION INFORMATION

The following procedure for selecting secondary fuse should be observed (Feeder Pillar fuse):

- a) Transformer ratings
 - Service voltage (U)
 - Rated output (S)
 - Relative short-circuit voltage (UK 4%)
 - Inrush current (factor 8..12 IN)
- b) Time current characteristics of HV/LV fuse links

3. Procedure based on an example:

A 50 kVA transformer has a transformer rated primary full load current of 2.6A with a ratio 11kV/415V. The short circuit current on secondary terminal short-circuit is given from the relative short-circuit voltage. The fuse should be selected to operate within 2 seconds as the transformer is designed to withstand minimum short circuit current (25 IN) for 2 seconds. The primary fuse link is selected to ensure withstand of primary inrush current of 12 IN for 0.1 seconds.

Selection of secondary fuse is based on the full load current which includes 130% overload withstand for 3 hours (secondary maximum current is 90.5A) and with temperature correction factor, the fuse-link rating of 125A is selected (Please refer to Mersen Feeder Pillar fuse range-BJU42V125PA).

To check whether the selected fuse is ok, the following conditions need to be satisfied.

- Referring to the curve above which consists of primary fuse time-current curve along with the secondary fuse time-current curve reflected on to primary, it is found that the selected secondary fuse will be operated within 2 seconds for minimum Short Circuit fault current on secondary side, thus protecting transformer from secondary faults

APPROVALS

Comparison chart for feeder pillar fuse links





GLOBAL EXPERT
IN ELECTRICAL POWER
AND ADVANCED MATERIALS.

EUROPE

UNITED KINGDOM
Mersen UK Teesside Limited Unit 12,
Tungsten Building, George Street,
Portslade, West Sussex, BN41 1RA
Tel: +44(0) 1273 425119
sales.ep.uk@mersen.com

FRANCE
Mersen France SB S.A.S.
Rue Jacques de Vaucanson
F-69720 Saint-Bonnet-de-Mure
Tel: + 33 4 72 22 66 11

NORTH AMERICA

USA
Mersen USA
Newburyport-MA L.L.C.
374 Merrimac Street
Newburyport, MA 01950
Tel: +1 978-462-6662

ASIA

INDIA
Mersen India Pvt. Ltd.
19, 4th Cross,
Bommasandra Industrial Area,
Bangalore - 560099
Tel: +91 80 27834001/5/6
E-mail: sales.ep.india@mersen.com



EP.MERSEN.COM